

## CPDT-5V0USP-HF

RoHS Device  
Halogen Free

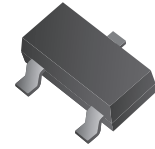

### Features

- IEC61000-4-2 Level 4 ESD protection
- Surface mount package.
- High component density.

### Mechanical data

- Case: SOT-23 Standard package, molded plastic.
- Terminals: Solderable per MIL-STD-750, method 2026.
- Mounting position: Any.
- Weight: 0.0078 grams(approx.).

### Circuit diagram

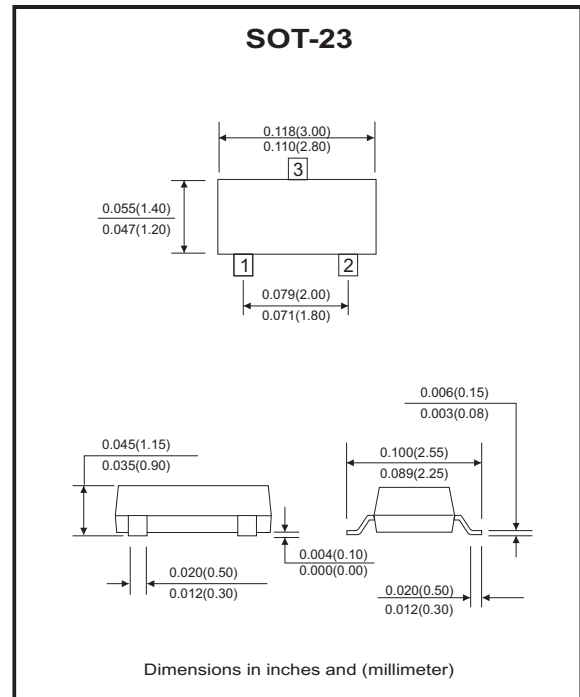
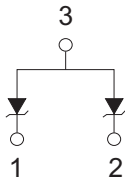

### Maximum Rating (at TA=25°C unless otherwise noted)

Parameter	Conditions	Symbol	Value	Unit
Peak pulse power	$T_P = 8/20\mu s$	$P_{PP}$	76	W
Peak pulse current	$T_P = 8/20\mu s$	$I_{PP}$	4	A
ESD capability	IEC 61000-4-2(air) IEC 61000-4-2(contact)	ESD	$\pm 15$ $\pm 8$	kV
Operation temperature range		$T_J$	-55~+150	°C
Storage temperature range		$T_{STG}$	-55~+150	°C

### Electrical Characteristics (at TA=25°C unless otherwise noted)

Parameter	Conditions	Symbol	Min	Typ	Max	Unit
Working peak reverse voltage		$V_{RWM}$			5	V
Breakdown voltage	$I_T = 1mA$	$V_{BR}$	6			V
Reverse leakage current	$V_{RWM} = 5V$	$I_R$			0.5	$\mu A$
Forward voltage	$I_F = 10mA$	$V_F$			1.2	V
Clamping voltage	$I_{PP} = 1A, T_P = 8/20\mu s$ $I_{PP} = 4A, T_P = 8/20\mu s$	$V_C$			12 19	V
Junction capacitance	$V_R = 0V, f = 1MHz$ (I/O pin to I/O pin)	$C_J$		0.3	0.45	pF
	$V_R = 0V, f = 1MHz$ (I/O pin to GND pin)	$C_J$		0.6	0.9	pF

## RATING AND CHARACTERISTIC CURVES (CPDT-5V0USP-HF)

Fig.1 - 8/20us Peak Pulse Current  
Wave Form Acc. IEC 61000-4-5

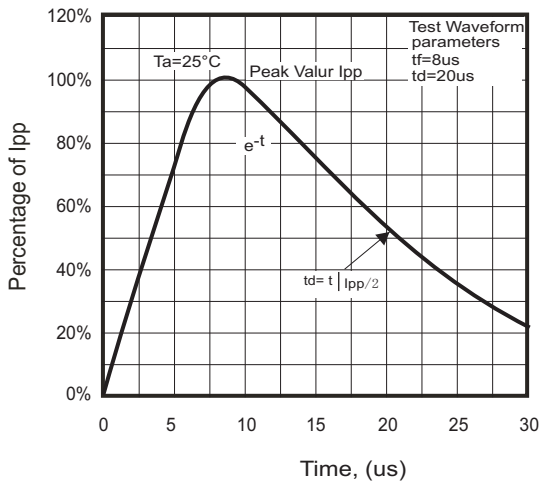

Fig.2 - Power Rating Derating Curve

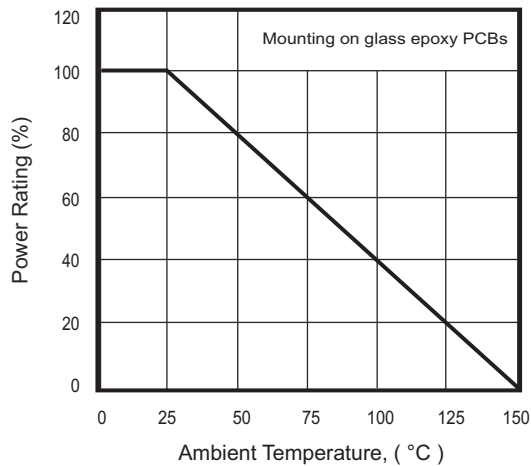

Fig.3 - Forward Characteristic

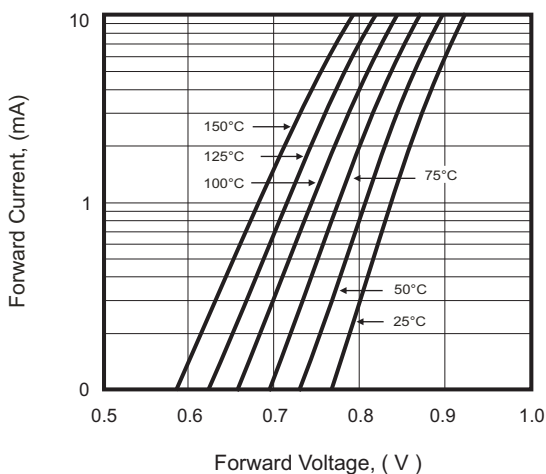

Fig.4 - Clamping Voltage Vs. Peak Pulse Current

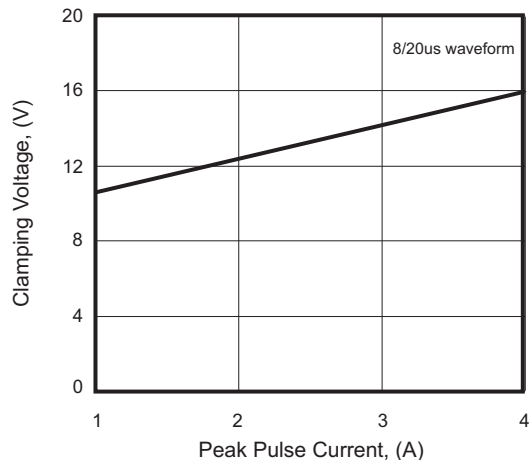
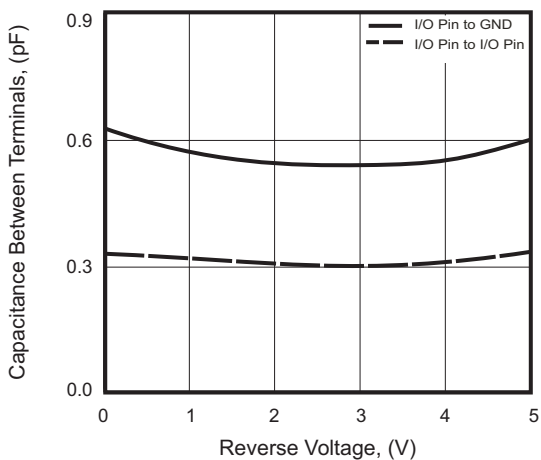
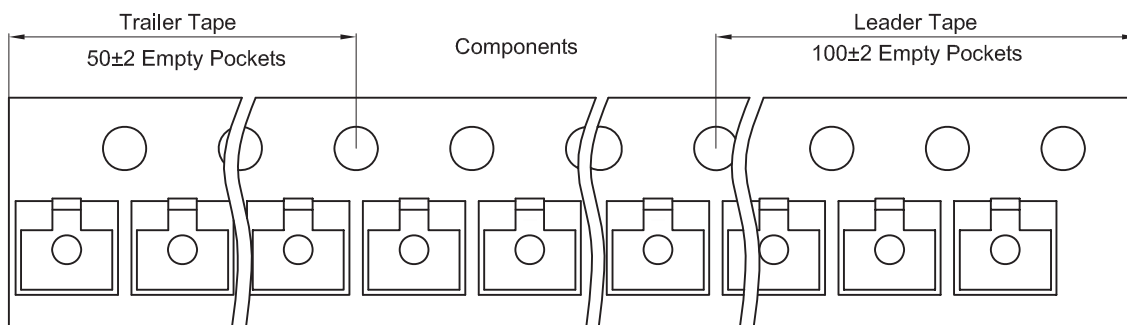
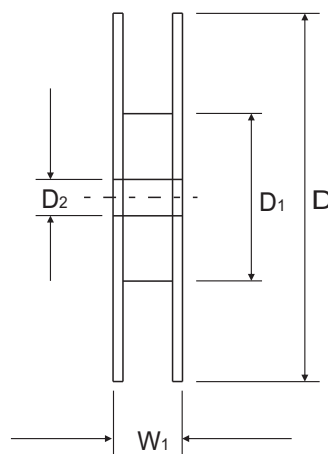
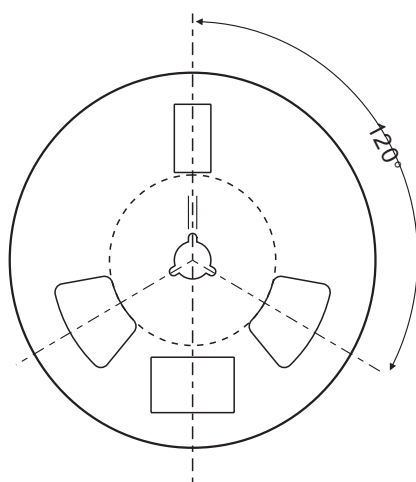
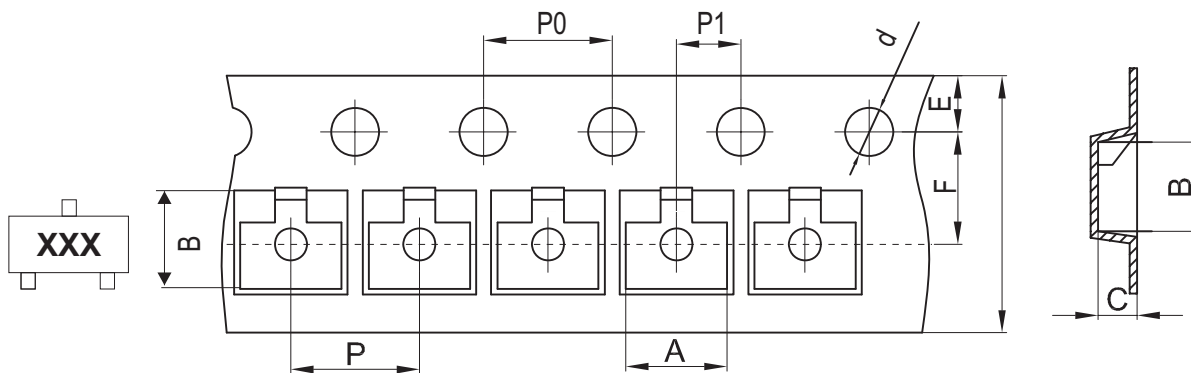

Fig.5 - Capacitance Between Terminals Characteristics



## Reel Taping Specification



SOT-23	SYMBOL	A	B	C	d	D	D1	D2
	(mm)	3.15 ± 0.10	2.77 ± 0.10	1.22 ± 0.10	1.50 ± 0.10	178.00 ± 2.00	54.40 ± 1.00	13.00 ± 1.00
	(inch)	0.124 ± 0.004	0.109 ± 0.004	0.048 ± 0.004	0.059 ± 0.004	7.008 ± 0.079	2.142 ± 0.039	0.512 ± 0.039

SOT-23	SYMBOL	E	F	P	P0	P1	W	W1
	(mm)	1.75 ± 0.10	3.50 ± 0.10	4.00 ± 0.10	4.00 ± 0.10	2.00 ± 0.10	8.00 + 0.30 / - 0.10	12.30 ± 1.00
	(inch)	0.069 ± 0.004	0.138 ± 0.004	0.157 ± 0.004	0.157 ± 0.004	0.079 ± 0.004	0.315 + 0.012 / - 0.004	0.484 ± 0.039

## Marking Code

Part Number	Marking Code
CPDT-5V0USP-HF	E5UP

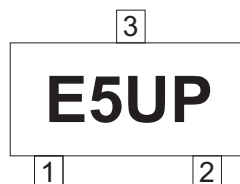

## Suggested PAD Layout

SIZE	SOT-23	
	(mm)	(inch)
A	0.80	0.031
B	1.90	0.075
C	2.02	0.080
D	2.82	0.111
E	0.80	0.031

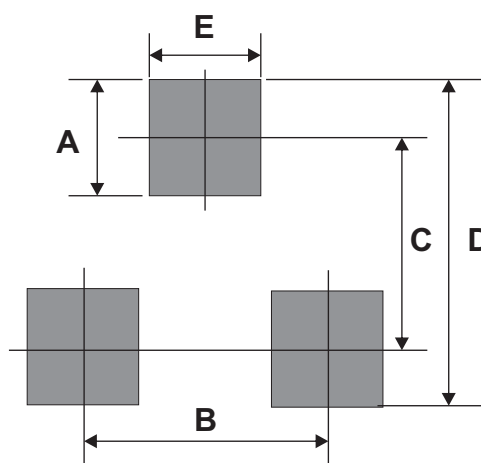

## Standard Packaging

Case Type	REEL PACK	
	REEL ( pcs )	Reel Size (inch)
SOT-23	3,000	7