

CMSH5-100HV
CMSH5-150HV
CMSH5-200HV

**SURFACE MOUNT SILICON
SCHOTTKY RECTIFIERS
5.0 AMP, 100 THRU 200 VOLT**



SMC CASE



www.centrasemi.com

DESCRIPTION:

The CENTRAL SEMICONDUCTOR CMSH5-100HV series 5.0 Amp surface mount silicon Schottky rectifiers are highly reliable components designed for use in all types of commercial, industrial, entertainment, computer, and lighting applications. To order devices on 16mm Tape and Reel (3000/13" Reel), add TR13 suffix to part number.

MARKING CODE: SEE MARKING CODE TABLE ON FOLLOWING PAGE

FEATURES:

- High voltage capability
- High reliability
- Energy efficiency
- Flammability classification UL94V-0
- "C" bend construction provides strain relief when mounted on PC board

MAXIMUM RATINGS: ($T_A=25^\circ\text{C}$ unless otherwise noted)

	SYMBOL	CMSH5 -100HV	CMSH5 -150HV	CMSH5 -200HV	UNITS
Peak Repetitive Reverse Voltage	V_{RRM}	100	150	200	V
DC Blocking Voltage	V_R	100	150	200	V
RMS Reverse Voltage	$V_R(RMS)$	70	105	140	V
Average Forward Current ($T_L=75^\circ\text{C}$)	I_O		5.0		A
Peak Forward Surge Current, $t_p=8.3\text{ms}$	I_{FSM}		100		A
Operating and Storage Junction Temperature	T_J, T_{stg}		-65 to +175		$^\circ\text{C}$
Thermal Resistance (Note 1)	θ_{JA}		50		$^\circ\text{C/W}$
Thermal Resistance (Note 1)	θ_{JL}		10		$^\circ\text{C/W}$

ELECTRICAL CHARACTERISTICS: ($T_A=25^\circ\text{C}$ unless otherwise noted)

SYMBOL	TEST CONDITIONS	TYP	MAX	UNITS
I_R	$V_R=Rated V_{RRM}$		50	μA
I_R	$V_R=Rated V_{RRM}, T_J=100^\circ\text{C}$		10	mA
V_F	$I_F=5.0\text{A}$ (CMSH5-100HV)	0.76	0.80	V
V_F	$I_F=5.0\text{A}$ (CMSH5-150HV)	0.80	0.90	V
V_F	$I_F=5.0\text{A}$ (CMSH5-200HV)	0.82	0.90	V
C_J	$V_R=0, f=1.0\text{MHz}$ (CMSH5-100HV)	498		pF
C_J	$V_R=0, f=1.0\text{MHz}$ (CMSH5-150HV)	451		pF
C_J	$V_R=0, f=1.0\text{MHz}$ (CMSH5-200HV)	334		pF

Note 1: FR-4 epoxy PCB with copper mounting pad area of 25.4mm².

CMSH5-100HV
 CMSH5-150HV
 CMSH5-200HV



**SURFACE MOUNT SILICON
 SCHOTTKY RECTIFIERS
 5.0 AMP, 100 THRU 200 VOLT**

SMC CASE - MECHANICAL OUTLINE

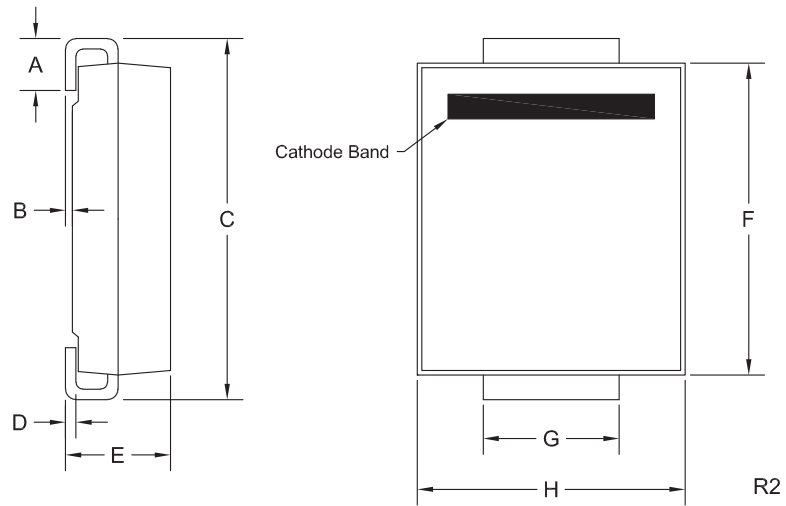

DEVICE	MARKING CODE
CMSH5-100HV	CS510HV
CMSH5-150HV	CS515HV
CMSH5-200HV	CS520HV

SYMBOL	DIMENSIONS			
	INCHES		MILLIMETERS	
	MIN	MAX	MIN	MAX
A	0.030	0.060	0.76	1.52
B	0.002	0.008	0.05	0.20
C	0.305	0.320	7.75	8.13
D	0.006	0.012	0.15	0.31
E	0.079	0.103	2.00	2.62
F	0.260	0.280	6.60	7.11
G	0.108	0.128	2.75	3.25
H	0.220	0.245	5.59	6.22

SMC (REV: R2)

R4 (22-December 2015)

CMSH5-100HV
 CMSH5-150HV
 CMSH5-200HV



SURFACE MOUNT SILICON
 SCHOTTKY RECTIFIERS
 5.0 AMP, 100 THRU 200 VOLT

TYPICAL ELECTRICAL CHARACTERISTICS

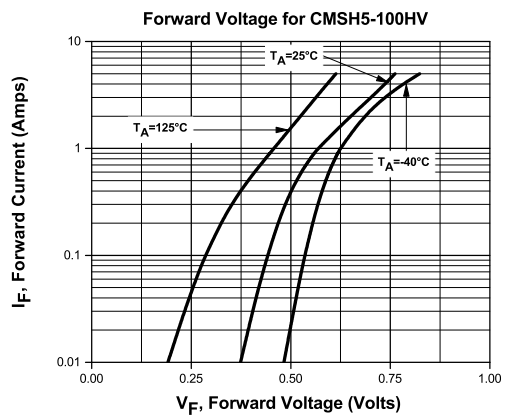
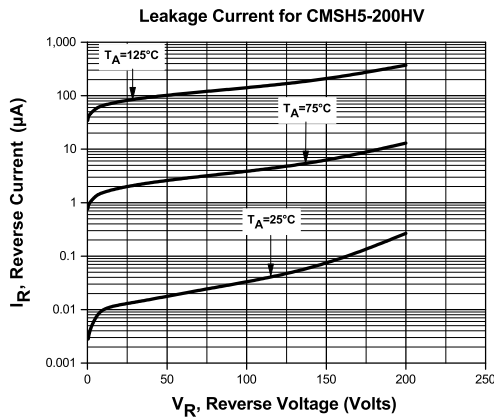
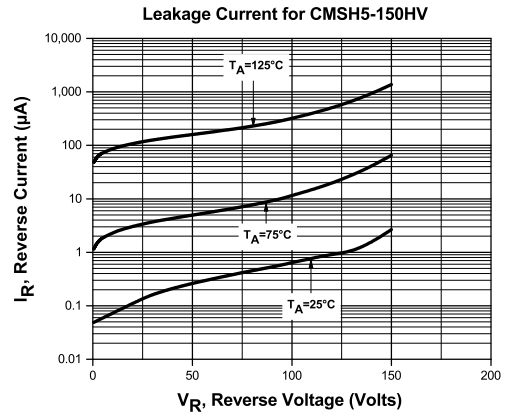
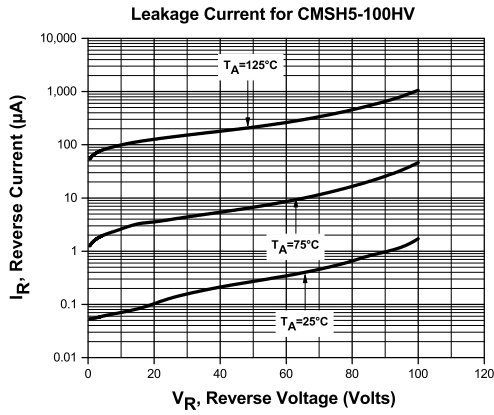

R4 (22-December 2015)

CMSH5-100HV
 CMSH5-150HV
 CMSH5-200HV



SURFACE MOUNT SILICON
 SCHOTTKY RECTIFIERS
 5.0 AMP, 100 THRU 200 VOLT

TYPICAL ELECTRICAL CHARACTERISTICS

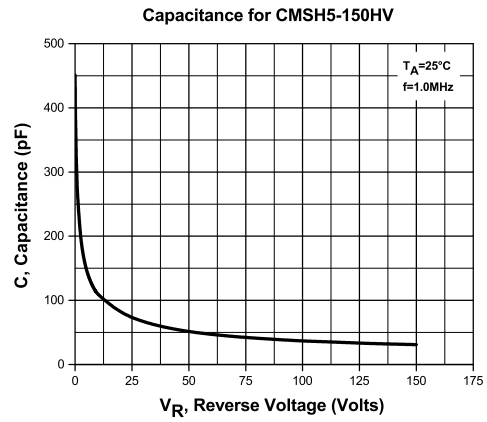
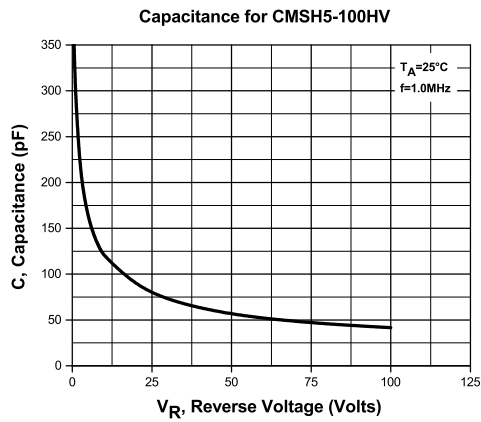
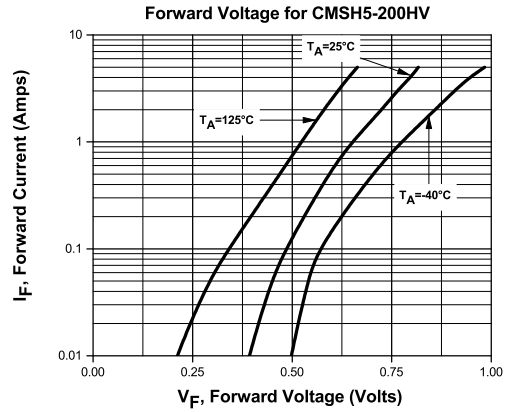
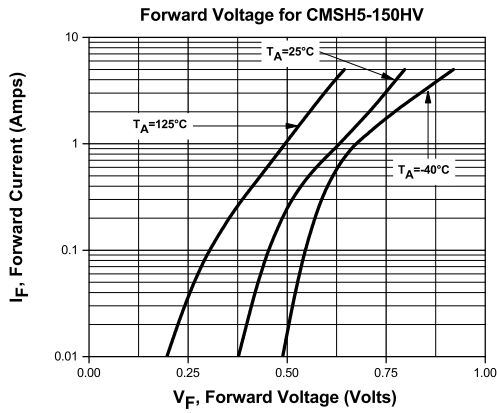

R4 (22-December 2015)

CMSH5-100HV
CMSH5-150HV
CMSH5-200HV

SURFACE MOUNT SILICON
SCHOTTKY RECTIFIERS
5.0 AMP, 100 THRU 200 VOLT



TYPICAL ELECTRICAL CHARACTERISTICS

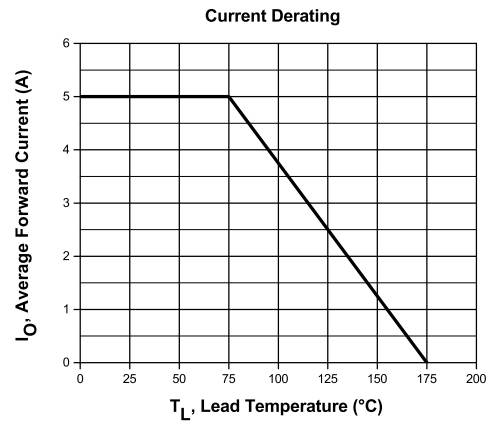
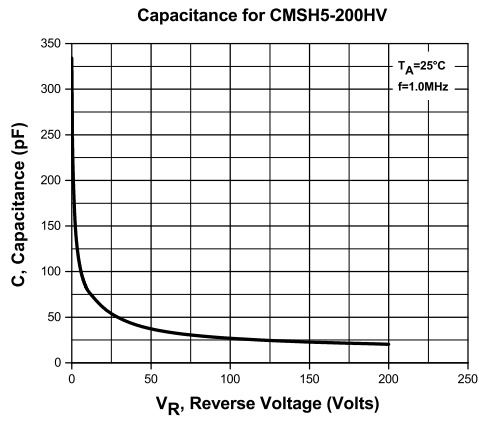

R4 (22-December 2015)

OUTSTANDING SUPPORT AND SUPERIOR SERVICES



PRODUCT SUPPORT

Central's operations team provides the highest level of support to insure product is delivered on-time.

- Supply management (Customer portals)
- Inventory bonding
- Consolidated shipping options
- Custom bar coding for shipments
- Custom product packing

DESIGNER SUPPORT/SERVICES

Central's applications engineering team is ready to discuss your design challenges. Just ask.

- Free quick ship samples (2nd day air)
- Online technical data and parametric search
- SPICE models
- Custom electrical curves
- Environmental regulation compliance
- Customer specific screening
- Up-screening capabilities
- Special wafer diffusions
- PbSn plating options
- Package details
- Application notes
- Application and design sample kits
- Custom product and package development

REQUESTING PRODUCT PLATING

1. If requesting Tin/Lead plated devices, add the suffix " TIN/LEAD" to the part number when ordering (example: 2N2222A TIN/LEAD).
2. If requesting Lead (Pb) Free plated devices, add the suffix " PBFREE" to the part number when ordering (example: 2N2222A PBFREE).

CONTACT US

Corporate Headquarters & Customer Support Team

Central Semiconductor Corp.
145 Adams Avenue
Hauppauge, NY 11788 USA
Main Tel: (631) 435-1110
Main Fax: (631) 435-1824
Support Team Fax: (631) 435-3388
www.centrasemi.com

Worldwide Field Representatives:
www.centrasemi.com/wwreps

Worldwide Distributors:
www.centrasemi.com/wwdistributors

For the latest version of Central Semiconductor's **LIMITATIONS AND DAMAGES DISCLAIMER**, which is part of Central's Standard Terms and Conditions of sale, visit: www.centrasemi.com/terms