

## N-Channel Depletion-Mode Vertical DMOS FET in Single and Dual Options

### Features

- Very Low Gate Threshold Voltage
- Designed to be Source-driven
- Low Switching Losses
- Low Effective Output Capacitance
- Designed for Inductive Loads

### Applications

- Medical Ultrasound Beamforming
- Ultrasonic Array-focusing Transmitter
- Piezoelectric Transducer Waveform Drivers
- High-speed Arbitrary Waveform Generator
- Normally-on Switches
- Solid-state Relays
- Constant Current Sources
- Power Supply Circuits

### General Description

The DN2625 is a low-threshold Depletion-mode (normally-on) transistor that utilizes an advanced vertical DMOS structure and a well-proven silicon gate manufacturing process. This combination produces a device with the power handling capabilities of bipolar transistors as well as the high input impedance and positive temperature coefficient inherent in Metal-Oxide Semiconductor (MOS) devices. Characteristic of all MOS structures, this device is free from thermal runaway and thermally induced secondary breakdown.

Vertical DMOS Field-Effect Transistors (FETs) are ideally suited to a wide range of switching and amplifying applications where high breakdown voltage, high input impedance, low input capacitance and fast switching speeds are desired.

The DN2625DK6-G contains two MOSFETs in an 8-lead, dual pad DFN package. The DN2625 contains a single MOSFET in a TO-252 D-PAK package.

### Package Types

**TO-252 D-PAK**

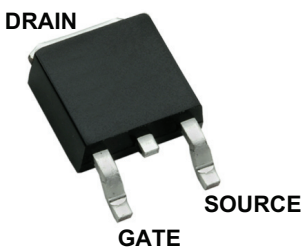

**8-lead DFN (Dual Pad)**  
(Top view)

S1	1	D1	8	D1
G1	2		7	D1
S2	3	D2	6	D2
G2	4		5	D2

See [Table 3-1](#) and [Table 3-2](#) for pin information.

# DN2625

## 1.0 ELECTRICAL CHARACTERISTICS

### Absolute Maximum Ratings †

Drain-to-source Voltage.....	250V
Drain-to-gate Voltage .....	250V
Gate-to-source Voltage .....	±20V
Operating Ambient Temperature, $T_A$ .....	-55°C to 150°C
Storage Temperature, $T_S$ .....	-55°C to 150°C
Soldering Temperature ( <b>Note 1</b> ).....	300°C

† **Notice:** Stresses above those listed under “Absolute Maximum Ratings” may cause permanent damage to the device. This is a stress rating only, and functional operation of the device at those or any other conditions above those indicated in the operational sections of this specification is not intended. Exposure to maximum rating conditions for extended periods may affect device reliability.

**Note 1:** Distance of 1.6 mm from case for 10 seconds

### ELECTRICAL CHARACTERISTICS

Electrical Specifications: Unless otherwise noted, $T_A = 25^\circ\text{C}$ .						
Parameter	Sym.	Min.	Typ.	Max.	Unit	Conditions
<b>DC PARAMETER</b>						
Drain-to-source Breakdown Voltage	$BV_{DSX}$	250	—	—	V	$V_{GS} = -2.5\text{V}$ , $I_D = 50\ \mu\text{A}$
Drain-to-gate Breakdown Voltage	$BV_{DGX}$	250	—	—	V	$V_{GS} = -2.5\text{V}$ , $I_D = 50\ \mu\text{A}$
Gate-to-source Off Voltage	$V_{GS(OFF)}$	-1.5	—	-2.1	V	$V_{DS} = 15\text{V}$ , $I_D = 100\ \mu\text{A}$
Change in $V_{GS(OFF)}$ with Temperature	$\Delta V_{GS(OFF)}$	—	—	-4.5	mV/°C	$V_{DS} = 15\text{V}$ , $I_D = 100\ \mu\text{A}$
Gate Body Leakage Current	$I_{GSS}$	—	—	100	nA	$V_{GS} = \pm 20\text{V}$ , $V_{DS} = 0\text{V}$
Drain-to-source Leakage Current	$I_{D(OFF)}$	—	—	1	$\mu\text{A}$	$V_{DS} = 250\text{V}$ , $V_{GS} = -5\text{V}$
		—	—	200		$V_{DS} = 250\text{V}$ , $V_{GS} = -5\text{V}$ , $T_A = 125^\circ\text{C}$
Saturated Drain-to-source Current	$I_{DSS}$	1.1	—	—	A	$V_{GS} = 0\text{V}$ , $V_{DS} = 15\text{V}$
Pulsed Drain-to-source Current	$I_{DS(PULSE)}$	3.1	3.3	—	A	$V_{GS} = 0.9\text{V}$ , $V_{DS} = 15\text{V}$ (With duty cycle of 1%)
Static Drain-to-source On-resistance	$R_{DS(ON)}$	—	—	3.5	$\Omega$	$V_{GS} = 0\text{V}$ , $I_D = 1\text{A}$
Change in $R_{DS(ON)}$ with Temperature	$\Delta R_{DS(ON)}$	—	—	1.1	%/°C	$V_{GS} = 0\text{V}$ , $I_D = 200\ \text{mA}$
<b>AC PARAMETER</b>						
Forward Transconductance	$G_{FS}$	100	—	—	mmh0	$V_{DS} = 10\text{V}$ , $I_D = 150\ \text{mA}$
Input Capacitance	$C_{ISS}$	—	800	1000	pF	$V_{GS} = -2.5\text{V}$ , $V_{DS} = 25\text{V}$ , $f = 1\ \text{MHz}$
Common Source Output Capacitance	$C_{OSS}$	—	70	210		
Reverse Transfer Capacitance	$C_{RSS}$	—	18	70		
Turn-on Delay Time	$t_{d(ON)}$	—	—	10	ns	$V_{DD} = 25\text{V}$ , $I_D = 150\ \text{mA}$ , $R_{GEN} = 3\Omega$ , $V_{GS} = 0\text{V to } -10\text{V}$
Rise Time	$t_r$	—	—	20		
Turn-off Delay Time	$t_{d(OFF)}$	—	—	10		
Fall Time	$t_f$	—	—	20		

## ELECTRICAL CHARACTERISTICS (CONTINUED)

Electrical Specifications: Unless otherwise noted, $T_A = 25^\circ\text{C}$ .						
Parameter	Sym.	Min.	Typ.	Max.	Unit	Conditions
<b>DIODE PARAMETER</b>						
Diode Forward Voltage Drop	$V_{SD}$	—	—	1.8	V	$V_{GS} = -2.5\text{V}$ , $I_{SD} = 150\text{ mA}$
Total Gate Charge	$Q_G$	—	—	7.04	nC	$I_D = 3.5\text{A}$ , $V_{DS} = 100\text{V}$ , $V_{GS} = 1.5\text{V}$
Gate-to-source Charge	$Q_{GS}$	—	—	0.783		
Gate-to-drain Charge	$Q_{GD}$	—	—	3.73		

## TEMPERATURE SPECIFICATIONS

Electrical Specifications: Unless otherwise specified, for all specifications $T_A = T_J = +25^\circ\text{C}$ .						
Parameter	Sym.	Min.	Typ.	Max.	Unit	Conditions
<b>TEMPERATURE RANGE</b>						
Operating Ambient Temperature	$T_A$	-55	—	150	$^\circ\text{C}$	
Storage Temperature	$T_S$	-55	—	150	$^\circ\text{C}$	
Soldering Temperature	—	—	—	300	$^\circ\text{C}$	Note 1
<b>PACKAGE THERMAL RESISTANCE</b>						
TO-252 D-PAK	$\theta_{JA}$	—	81	—	$^\circ\text{C/W}$	Note 2
8-lead DFN (Dual Pad)	$\theta_{JA}$	—	29	—	$^\circ\text{C/W}$	Note 3

- Note 1:** Distance of 1.6 mm from case for 10 seconds  
**2:** Four-layer, 1-oz, 3 x 4-inch PCB with 20 via for drain pad  
**3:** Four-layer, 1-oz, 3 x 4-inch PCB with 12 via for drain pad

## THERMAL CHARACTERISTICS

Package	$I_D$ (Note 1) (Continuous) (A)	$I_D$ (Pulsed) (A)	$I_{DR}$ (Note 1) (A)	$I_{DRM}$ (A)
TO-252 D-PAK	1.1	3.3	1.1	3.3
8-lead DFN (Dual Pad)	1.1	3.3	1.1	3.3

**Note 1:**  $I_D$  (Continuous) is limited by maximum  $T_J$ .

## 2.0 TYPICAL PERFORMANCE CURVES

**Note:** The graphs and tables provided following this note are a statistical summary based on a limited number of samples and are provided for informational purposes only. The performance characteristics listed herein are not tested or guaranteed. In some graphs or tables, the data presented may be outside the specified operating range (e.g. outside specified power supply range) and therefore outside the warranted range.

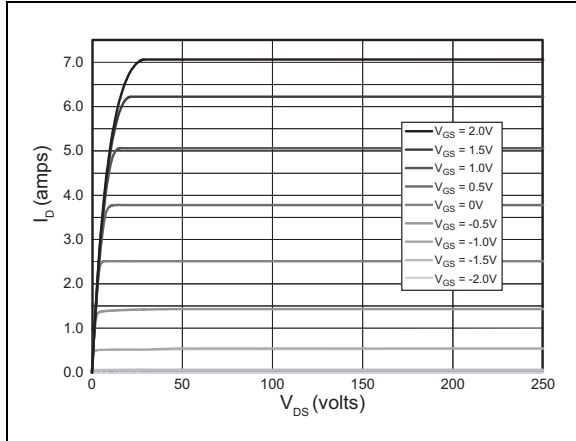

**FIGURE 2-1:** Output Characteristics.

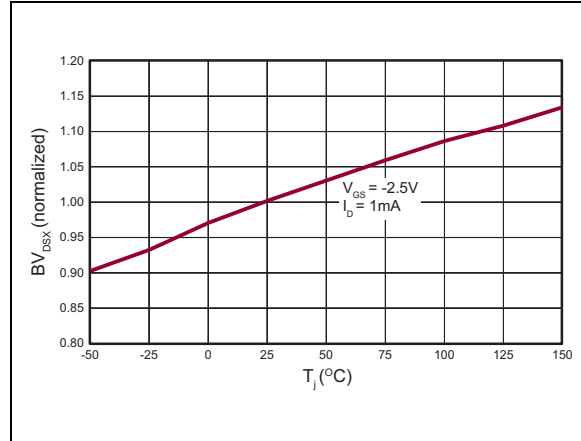

**FIGURE 2-4:**  $BV_{DSX}$  Variation with Temperature.

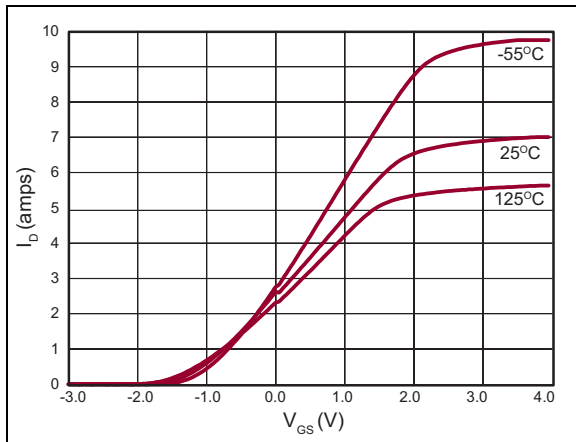

**FIGURE 2-2:** Transfer Characteristics.

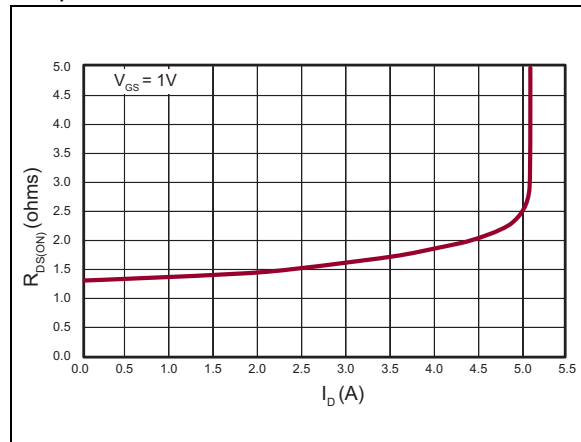

**FIGURE 2-5:** On-resistance vs. Drain Current.

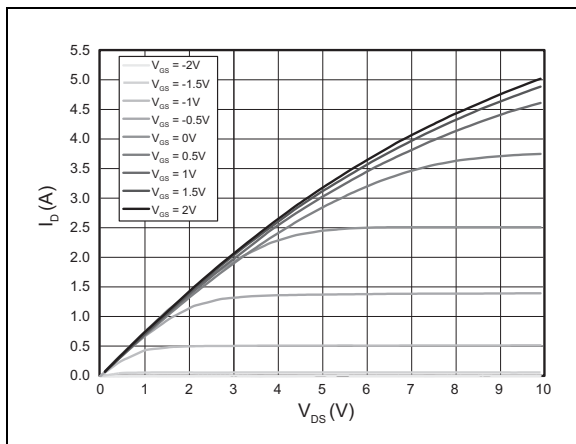

**FIGURE 2-3:** Saturation Characteristics.

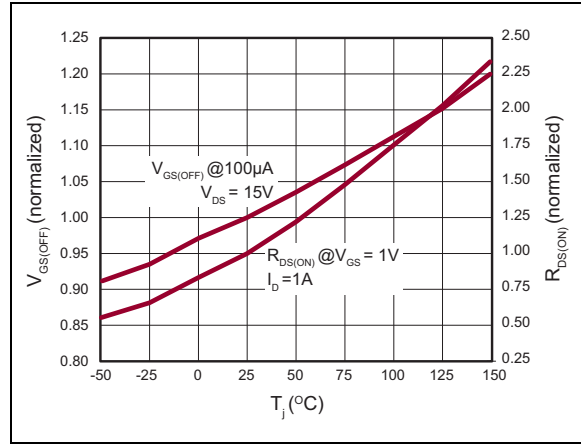

**FIGURE 2-6:**  $V_{GS(OFF)}$  and  $R_{DS(ON)}$  Variation with Temperature.

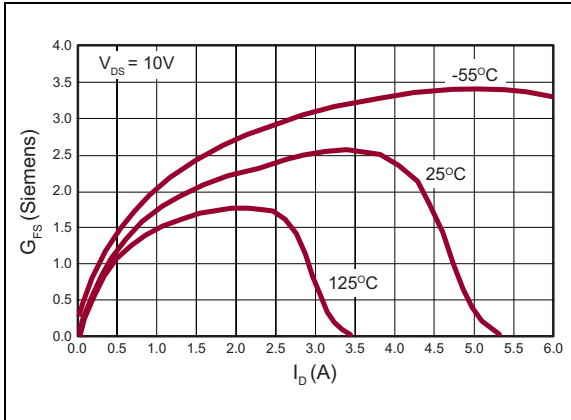

**FIGURE 2-7:** Transconductance vs. Drain Current.

# DN2625

---

## 3.0 PIN DESCRIPTION

The details on the pins of TO-252 D-PAK and 8-lead DFN (dual pad) are listed in [Table 3-1](#) and [Table 3-2](#). Refer to [Package Types](#) for the location of pins.

**TABLE 3-1: TO-252 D-PAK PIN FUNCTION TABLE**

Pin Number	Pin Name	Description
1	Gate	Gate
2	Drain	Drain
3	Source	Source
4	Drain	Drain

**TABLE 3-2: 8-LEAD DFN (DUAL PAD) PIN FUNCTION TABLE**

Pin Number	Pin Name	Description
1	S1	Device 1 source
2	G1	Device 1 gate
3	S2	Device 2 source
4	G2	Device 2 gate
5	D2	Device 2 drain
6	D2	Device 2 drain
7	D1	Device 1 drain
8	D1	Device 1 drain

## 4.0 FUNCTIONAL DESCRIPTION

Figure 4-1 shows the switching waveforms and test circuit for DN2625.

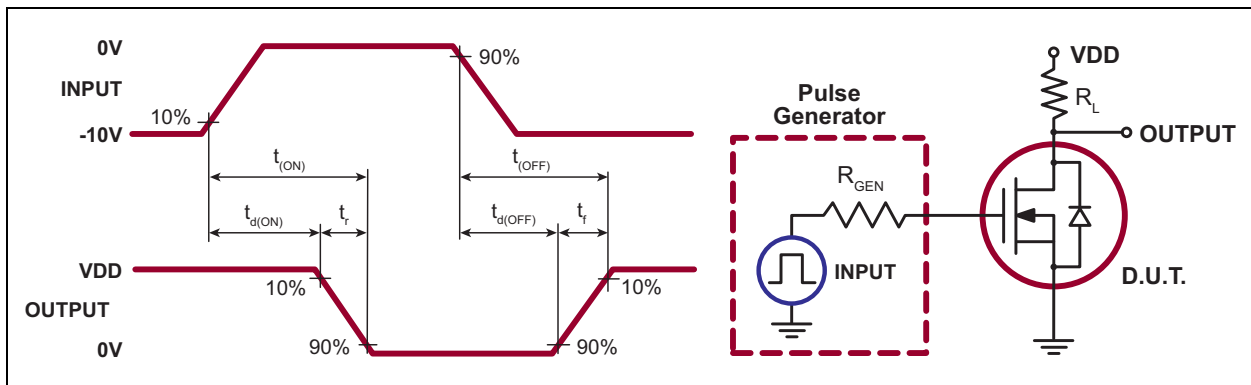

**FIGURE 4-1:** Switching Waveforms and Test Circuit.

## PRODUCT SUMMARY

$BV_{DSX}/BV_{DGX}$ (V)	$V_{GS(OFF)}$ (max) (V)	$I_{DS}$ (Pulsed) ( $V_{GS} = 0.9V$ ) (min) (A)
250	-2.1	3.3

# DN2625

## 5.0 PACKAGING INFORMATION

### 5.1 Package Marking Information

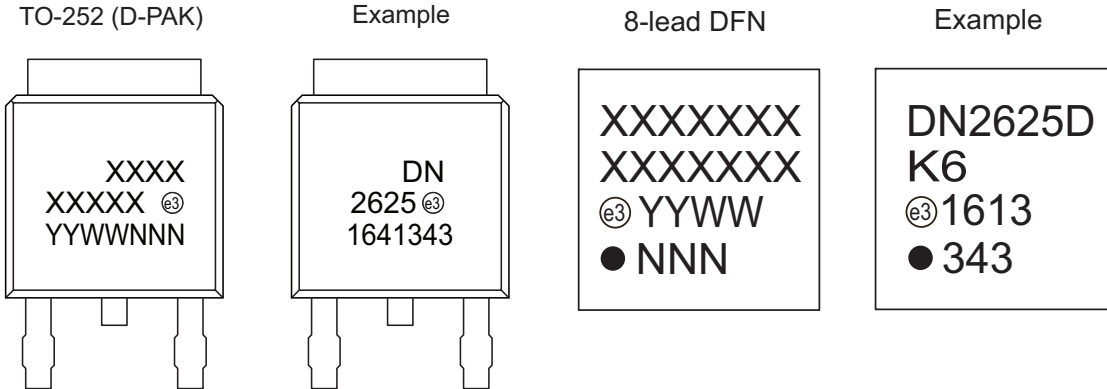

<b>Legend:</b>	XX...X	Product Code or Customer-specific information
	Y	Year code (last digit of calendar year)
	YY	Year code (last 2 digits of calendar year)
	WW	Week code (week of January 1 is week '01')
	NNN	Alphanumeric traceability code
	(e3)	Pb-free JEDEC® designator for Matte Tin (Sn)
	*	This package is Pb-free. The Pb-free JEDEC designator (e3) can be found on the outer packaging for this package.

**Note:** In the event the full Microchip part number cannot be marked on one line, it will be carried over to the next line, thus limiting the number of available characters for product code or customer-specific information. Package may or not include the corporate logo.



## 3-Lead TO-252 (D-PAK) Package Outline (K4)

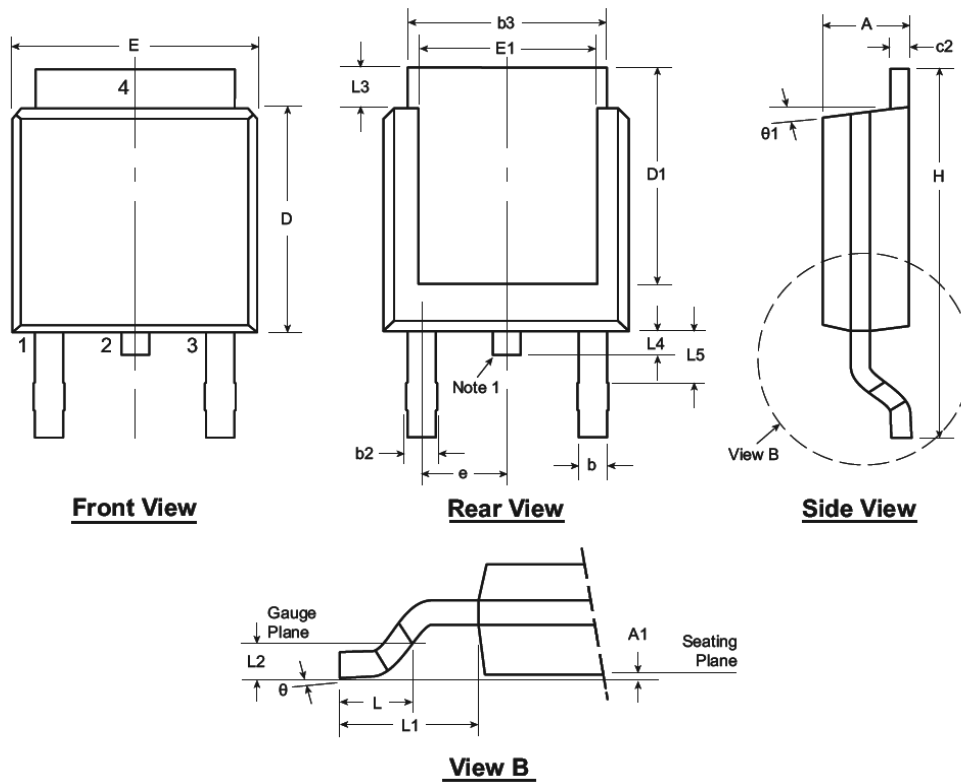

Note: For the most current package drawings, see the Microchip Packaging Specification at [www.microchip.com/packaging](http://www.microchip.com/packaging).

**Note:**

- Although 4 terminal locations are shown, only 3 are functional. Lead number 2 was removed.

Symbol	A	A1	b	b2	b3	c2	D	D1	E	E1	e	H	L	L1	L2	L3	L4	L5	θ	θ1
Dimension (inches)	MIN	.086	.000*	.025	.030	.195	.018	.235	.205	.250	.170	.370	.055	.108 REF	.020 BSC	.035	.025*	.035†	0°	0°
	NOM	-	-	-	-	-	-	.240	-	-	.090 BSC	-	.060	-	-	-	-	-	-	-
	MAX	.094	.005	.035	.045	.215	.035	.245	.217*	.265	.200*	.410	.070	-	-	.050	.040	.060	10°	15°

JEDEC Registration TO-252, Variation AA, Issue E, June 2004.

\* This dimension is not specified in the JEDEC drawing.

† This dimension differs from the JEDEC drawing.

Drawings not to scale.

# DN2625

## 8-Lead DFN Package Outline (K6)

4.00x4.00mm body, 1.00mm height (max), 1.00mm pitch (dual pad)

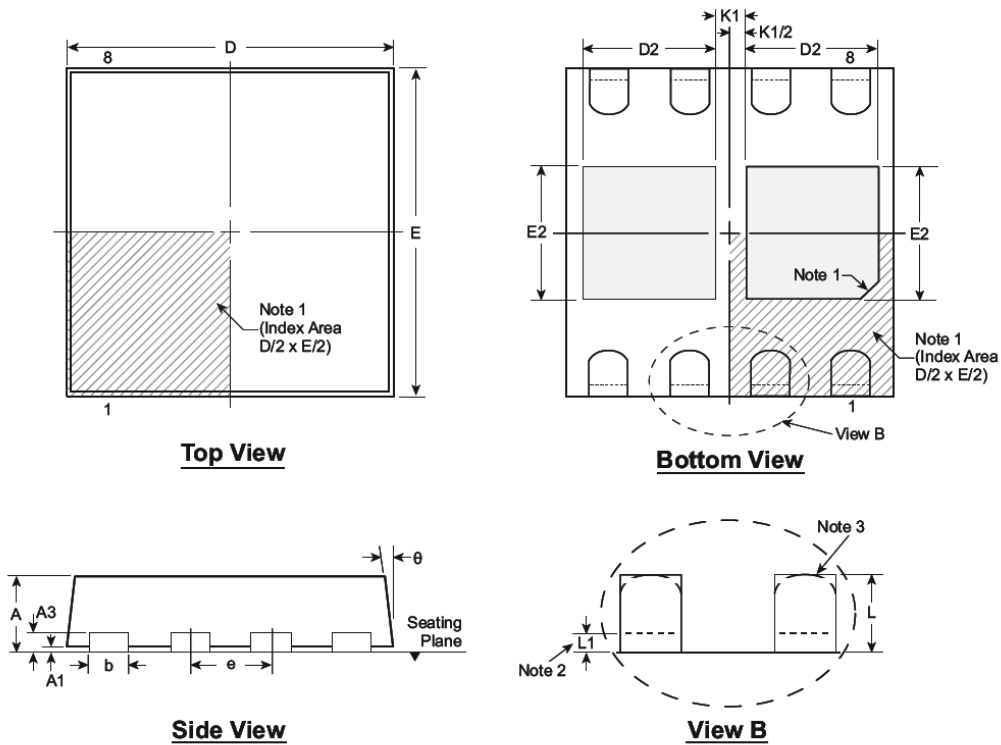

Note: For the most current package drawings, see the Microchip Packaging Specification at [www.microchip.com/packaging](http://www.microchip.com/packaging).

**Notes:**

1. A Pin 1 identifier must be located in the index area indicated. The Pin 1 identifier can be: a molded mark/identifier; an embedded metal marker; or a printed indicator.
2. Depending on the method of manufacturing, a maximum of 0.15mm pullback (L1) may be present.
3. The inner tip of the lead may be either rounded or square.

Symbol	A	A1	A3	b	D	D2	E	E2	e	K1	L	L1	$\theta$	
Dimension (mm)	MIN	0.80	0.00	0.20 REF	0.25	3.90	1.35	3.90	1.35	1.00 BSC	0.50 REF	0.40	0.00	0°
	NOM	0.90	-		0.30	4.00	1.45	4.00	1.45			0.50	-	-
	MAX	1.00	0.05		0.35	4.10	1.55	4.10	1.55			0.60	0.15	14°

Drawings not to scale

## APPENDIX A: REVISION HISTORY

### Revision A (December 2016)

- Converted Supertex Document DSFP-DN2625 to Microchip DS20005537A
- Removed obsolete package, 14-lead QFN
- Changed the TO-252 D-PAK packaging quantity from 1000/Bag to 2000/Reel
- Revised the Features section

# DN2625

## PRODUCT IDENTIFICATION SYSTEM

To order or obtain information, e.g., on pricing or delivery, refer to the factory or the listed sales office.

<u>PART NO.</u>	<u>XX</u>	-	<u>X</u>	-	<u>X</u>
Device	Package Options		Environmental		Media Type
Device:	DN2625	=	N-Channel Depletion-Mode Vertical DMOS FET (Single Option)		
	DN2625D	=	N-Channel Depletion-Mode Vertical DMOS FET (Dual Option)		
Packages:	K4	=	TO-252 D-PAK		
	K6	=	8-lead DFN		
Environmental	G	=	Lead (Pb)-free/RoHS-compliant Package		
Media Type:	(blank)	=	2000/Reel for a K4 Package		
		=	490/Tray for a K6 Package		

<b>Examples:</b>	
a) DN2625K4-G:	N-Channel Depletion-Mode Vertical DMOS FET (Single Option), TO-252 D-PAK Package, 2000/Reel
b) DN2625DK6-G:	N-Channel Depletion-Mode Vertical DMOS FET (Dual Option), 8-lead DFN Package, 490/Tray

---

---

**Note the following details of the code protection feature on Microchip devices:**

- Microchip products meet the specification contained in their particular Microchip Data Sheet.
- Microchip believes that its family of products is one of the most secure families of its kind on the market today, when used in the intended manner and under normal conditions.
- There are dishonest and possibly illegal methods used to breach the code protection feature. All of these methods, to our knowledge, require using the Microchip products in a manner outside the operating specifications contained in Microchip's Data Sheets. Most likely, the person doing so is engaged in theft of intellectual property.
- Microchip is willing to work with the customer who is concerned about the integrity of their code.
- Neither Microchip nor any other semiconductor manufacturer can guarantee the security of their code. Code protection does not mean that we are guaranteeing the product as “unbreakable.”

Code protection is constantly evolving. We at Microchip are committed to continuously improving the code protection features of our products. Attempts to break Microchip's code protection feature may be a violation of the Digital Millennium Copyright Act. If such acts allow unauthorized access to your software or other copyrighted work, you may have a right to sue for relief under that Act.

---

Information contained in this publication regarding device applications and the like is provided only for your convenience and may be superseded by updates. It is your responsibility to ensure that your application meets with your specifications. MICROCHIP MAKES NO REPRESENTATIONS OR WARRANTIES OF ANY KIND WHETHER EXPRESS OR IMPLIED, WRITTEN OR ORAL, STATUTORY OR OTHERWISE, RELATED TO THE INFORMATION, INCLUDING BUT NOT LIMITED TO ITS CONDITION, QUALITY, PERFORMANCE, MERCHANTABILITY OR FITNESS FOR PURPOSE. Microchip disclaims all liability arising from this information and its use. Use of Microchip devices in life support and/or safety applications is entirely at the buyer's risk, and the buyer agrees to defend, indemnify and hold harmless Microchip from any and all damages, claims, suits, or expenses resulting from such use. No licenses are conveyed, implicitly or otherwise, under any Microchip intellectual property rights unless otherwise stated.

*Microchip received ISO/TS-16949:2009 certification for its worldwide headquarters, design and wafer fabrication facilities in Chandler and Tempe, Arizona; Gresham, Oregon and design centers in California and India. The Company's quality system processes and procedures are for its PIC® MCUs and dsPIC® DSCs, KEELOQ® code hopping devices, Serial EEPROMs, microperipherals, nonvolatile memory and analog products. In addition, Microchip's quality system for the design and manufacture of development systems is ISO 9001:2000 certified.*

**QUALITY MANAGEMENT SYSTEM  
CERTIFIED BY DNV  
= ISO/TS 16949 =**

### Trademarks

The Microchip name and logo, the Microchip logo, AnyRate, AVR, AVR logo, AVR Freaks, BeaconThings, BitCloud, CryptoMemory, CryptoRF, dsPIC, FlashFlex, flexPWR, Helder, JukeBlox, KEELOQ, KEELOQ logo, Klear, LANCheck, LINK MD, maXStylus, maXTouch, MediaLB, megaAVR, MOST, MOST logo, MPLAB, OptoLyzer, PIC, picoPower, PICSTART, PIC32 logo, Prochip Designer, QTouch, RightTouch, SAM-BA, SpyNIC, SST, SST Logo, SuperFlash, tinyAVR, UNI/O, and XMEGA are registered trademarks of Microchip Technology Incorporated in the U.S.A. and other countries.

ClockWorks, The Embedded Control Solutions Company, EtherSynch, Hyper Speed Control, HyperLight Load, IntelliMOS, mTouch, Precision Edge, and Quiet-Wire are registered trademarks of Microchip Technology Incorporated in the U.S.A.

Adjacent Key Suppression, AKS, Analog-for-the-Digital Age, Any Capacitor, AnyIn, AnyOut, BodyCom, chipKIT, chipKIT logo, CodeGuard, CryptoAuthentication, CryptoCompanion, CryptoController, dsPICDEM, dsPICDEM.net, Dynamic Average Matching, DAM, ECAN, EtherGREEN, In-Circuit Serial Programming, ICSP, Inter-Chip Connectivity, JitterBlocker, KlearNet, KlearNet logo, Mindi, MiWi, motorBench, MPASM, MPF, MPLAB Certified logo, MPLIB, MPLINK, MultiTRAK, NetDetach, Omniscient Code Generation, PICDEM, PICDEM.net, PICKit, PICTail, PureSilicon, QMatrix, RightTouch logo, REAL ICE, Ripple Blocker, SAM-ICE, Serial Quad I/O, SMART-I.S., SQI, SuperSwitcher, SuperSwitcher II, Total Endurance, TSHARC, USBCheck, VariSense, ViewSpan, WiperLock, Wireless DNA, and ZENA are trademarks of Microchip Technology Incorporated in the U.S.A. and other countries.

SQTP is a service mark of Microchip Technology Incorporated in the U.S.A.

Silicon Storage Technology is a registered trademark of Microchip Technology Inc. in other countries.

GestIC is a registered trademark of Microchip Technology Germany II GmbH & Co. KG, a subsidiary of Microchip Technology Inc., in other countries.

All other trademarks mentioned herein are property of their respective companies.

© 2016, Microchip Technology Incorporated, All Rights Reserved.  
ISBN: 978-1-5224-1163-5



# MICROCHIP

## Worldwide Sales and Service

### AMERICAS

#### Corporate Office

2355 West Chandler Blvd.  
Chandler, AZ 85224-6199

Tel: 480-792-7200

Fax: 480-792-7277

Technical Support:

[http://www.microchip.com/  
support](http://www.microchip.com/support)

Web Address:

[www.microchip.com](http://www.microchip.com)

#### Atlanta

Duluth, GA

Tel: 678-957-9614

Fax: 678-957-1455

#### Austin, TX

Tel: 512-257-3370

#### Boston

Westborough, MA

Tel: 774-760-0087

Fax: 774-760-0088

#### Chicago

Itasca, IL

Tel: 630-285-0071

Fax: 630-285-0075

#### Dallas

Addison, TX

Tel: 972-818-7423

Fax: 972-818-2924

#### Detroit

Novi, MI

Tel: 248-848-4000

#### Houston, TX

Tel: 281-894-5983

#### Indianapolis

Noblesville, IN

Tel: 317-773-8323

Fax: 317-773-5453

Tel: 317-536-2380

#### Los Angeles

Mission Viejo, CA

Tel: 949-462-9523

Fax: 949-462-9608

Tel: 951-273-7800

#### Raleigh, NC

Tel: 919-844-7510

#### New York, NY

Tel: 631-435-6000

#### San Jose, CA

Tel: 408-735-9110

Tel: 408-436-4270

#### Canada - Toronto

Tel: 905-695-1980

Fax: 905-695-2078

### ASIA/PACIFIC

#### Asia Pacific Office

Suites 3707-14, 37th Floor  
Tower 6, The Gateway  
Harbour City, Kowloon

#### Hong Kong

Tel: 852-2943-5100

Fax: 852-2401-3431

#### Australia - Sydney

Tel: 61-2-9868-6733

Fax: 61-2-9868-6755

#### China - Beijing

Tel: 86-10-8569-7000

Fax: 86-10-8528-2104

#### China - Chengdu

Tel: 86-28-8665-5511

Fax: 86-28-8665-7889

#### China - Chongqing

Tel: 86-23-8980-9588

Fax: 86-23-8980-9500

#### China - Dongguan

Tel: 86-769-8702-9880

#### China - Guangzhou

Tel: 86-20-8755-8029

#### China - Hangzhou

Tel: 86-571-8792-8115

Fax: 86-571-8792-8116

#### China - Hong Kong SAR

Tel: 852-2943-5100

Fax: 852-2401-3431

#### China - Nanjing

Tel: 86-25-8473-2460

Fax: 86-25-8473-2470

#### China - Qingdao

Tel: 86-532-8502-7355

Fax: 86-532-8502-7205

#### China - Shanghai

Tel: 86-21-3326-8000

Fax: 86-21-3326-8021

#### China - Shenyang

Tel: 86-24-2334-2829

Fax: 86-24-2334-2393

#### China - Shenzhen

Tel: 86-755-8864-2200

Fax: 86-755-8203-1760

#### China - Wuhan

Tel: 86-27-5980-5300

Fax: 86-27-5980-5118

#### China - Xian

Tel: 86-29-8833-7252

Fax: 86-29-8833-7256

### ASIA/PACIFIC

#### China - Xiamen

Tel: 86-592-2388138

Fax: 86-592-2388130

#### China - Zhuhai

Tel: 86-756-3210040

Fax: 86-756-3210049

#### India - Bangalore

Tel: 91-80-3090-4444

Fax: 91-80-3090-4123

#### India - New Delhi

Tel: 91-11-4160-8631

Fax: 91-11-4160-8632

#### India - Pune

Tel: 91-20-3019-1500

#### Japan - Osaka

Tel: 81-6-6152-7160

Fax: 81-6-6152-9310

#### Japan - Tokyo

Tel: 81-3-6880-3770

Fax: 81-3-6880-3771

#### Korea - Daegu

Tel: 82-53-744-4301

Fax: 82-53-744-4302

#### Korea - Seoul

Tel: 82-2-554-7200

Fax: 82-2-558-5932 or

82-2-558-5934

#### Malaysia - Kuala Lumpur

Tel: 60-3-6201-9857

Fax: 60-3-6201-9859

#### Malaysia - Penang

Tel: 60-4-227-8870

Fax: 60-4-227-4068

#### Philippines - Manila

Tel: 63-2-634-9065

Fax: 63-2-634-9069

#### Singapore

Tel: 65-6334-8870

Fax: 65-6334-8850

#### Taiwan - Hsin Chu

Tel: 886-3-5778-366

Fax: 886-3-5770-955

#### Taiwan - Kaohsiung

Tel: 886-7-213-7830

#### Taiwan - Taipei

Tel: 886-2-2508-8600

Fax: 886-2-2508-0102

#### Thailand - Bangkok

Tel: 66-2-694-1351

Fax: 66-2-694-1350

### EUROPE

#### Austria - Wels

Tel: 43-7242-2244-39

Fax: 43-7242-2244-393

#### Denmark - Copenhagen

Tel: 45-4450-2828

Fax: 45-4485-2829

#### Finland - Espoo

Tel: 358-9-4520-820

#### France - Paris

Tel: 33-1-69-53-63-20

Fax: 33-1-69-30-90-79

#### France - Saint Cloud

Tel: 33-1-30-60-70-00

#### Germany - Garching

Tel: 49-8931-9700

#### Germany - Haan

Tel: 49-2129-3766400

#### Germany - Heilbronn

Tel: 49-7131-67-3636

#### Germany - Karlsruhe

Tel: 49-721-625370

#### Germany - Munich

Tel: 49-89-627-144-0

Fax: 49-89-627-144-44

#### Germany - Rosenheim

Tel: 49-8031-354-560

#### Israel - Ra'anana

Tel: 972-9-744-7705

#### Italy - Milan

Tel: 39-0331-742611

Fax: 39-0331-466781

#### Italy - Padova

Tel: 39-049-7625286

#### Netherlands - Drunen

Tel: 31-416-690399

Fax: 31-416-690340

#### Norway - Trondheim

Tel: 47-7289-7561

#### Poland - Warsaw

Tel: 48-22-3325737

#### Romania - Bucharest

Tel: 40-21-407-87-50

#### Spain - Madrid

Tel: 34-91-708-08-90

Fax: 34-91-708-08-91

#### Sweden - Gothenberg

Tel: 46-31-704-60-40

#### Sweden - Stockholm

Tel: 46-8-5090-4654

#### UK - Wokingham

Tel: 44-118-921-5800

Fax: 44-118-921-5820