

- N-Channel Application-Specific MOSFET
- Ideal for CPU Core DC-DC Converters
- Low Conduction Losses
- Minimizes Parallel MOSFETs for high current applications
- 100% R_G Tested

HEXFET® MOSFET for DC-DC Converters

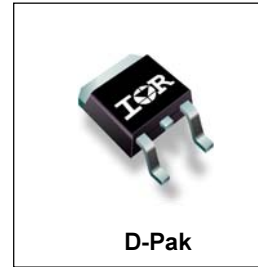
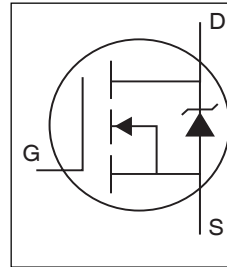

Description

This new device employs advanced HEXFET Power MOSFET technology to achieve very low on-resistance. The reduced conduction losses makes it ideal for high efficiency DC-DC converters that power the latest generation of microprocessors.

The IRLR8503 has been optimized and is 100% tested for all parameters that are critical in synchronous buck converters including $R_{DS(on)}$, gate charge and Cdv/dt -induced turn-on immunity. The IRLR8503 offers an extremely low combination of Q_{sw} & $R_{DS(on)}$ for reduced losses in control FET applications.

The package is designed for vapor phase, infra-red, convection, or wave soldering techniques. Power dissipation of greater than 2W is possible in a typical PCB mount application.

DEVICE RATINGS (MAX. Values)

	IRLR8503
V_{DS}	30V
$R_{DS(on)}$	18 mΩ
Q_G	20 nC
Q_{SW}	8 nC
Q_{OSS}	29.5 nC

Absolute Maximum Ratings

Parameter	Symbol	IRLR8503	Units
Drain-Source Voltage	V_{DS}	30	V
Gate-Source Voltage	V_{GS}	±20	
Continuous Drain or Source Current	I_D	$T_C = 25^\circ C$	44
		$T_C = 90^\circ C$	32
Pulsed Drain Current ①	I_{DM}	196	A
Power Dissipation ⑤	P_D	$T_C = 25^\circ C$	62
		$T_C = 90^\circ C$	30
Junction & Storage Temperature Range	T_J, T_{STG}	-55 to 150	°C
Continuous Source Current (Body Diode)	I_S	15	A
Pulsed Source Current ①	I_{SM}	196	

Thermal Resistance

Parameter	Symbol	Typ	Max	Units
Maximum Junction-to-Ambient ③ ⑥	$R_{\theta JA}$	—	50	°C/W
Maximum Junction-to-Lead ⑥	$R_{\theta JL}$	—	2.0	

Electrical Characteristics

Parameter	Symbol	Min	Typ	Max	Units	Conditions
Drain-to-Source Breakdown Voltage*	$V_{(BR)DSS}$	30	—	—	V	$V_{GS} = 0V, I_D = 250\mu A$
Static Drain-Source On-Resistance*	$R_{DS(on)}$	—	11	16	m Ω	$V_{GS} = 10V, I_D = 15A$ ②
		—	13	18		$V_{GS} = 4.5V, I_D = 15A$
Gate Threshold Voltage*	$V_{GS(th)}$	1.0	—	3.0	V	$V_{DS} = V_{GS}, I_D = 250\mu A$
Drain-Source Leakage Current	I_{DSS}	—	—	1.0	μA	$V_{DS} = 30V, V_{GS} = 0$
		—	—	150		$V_{DS} = 24V, V_{GS} = 0, T_J = 100^\circ C$
Gate-Source Leakage Current*	I_{GSS}	—	—	± 100	nA	$V_{GS} = \pm 20V$
Total Gate Charge, Control FET*	Q_g	—	15	20	nC	$V_{GS} = 5V, I_D = 15A, V_{DS} = 16V$
Total Gate Charge, Synch FET*	Q_g	—	13	17		$V_{GS} = 5V, V_{DS} < 100mV$
Pre-Vth Gate-to-Source Charge	Q_{gs1}	—	3.7	—		$V_{DS} = 16V, I_D = 15A$
Post-Vth Gate-to-Source Charge	Q_{gs2}	—	1.3	—		
Gate-to-Drain Charge	Q_{gd}	—	4.1	—		
Switch Charge* ($Q_{gs2} + Q_{gd}$)	Q_{SW}	—	5.4	8		
Output Charge*	Q_{OSS}	—	23	29.5		$V_{DS} = 16V, V_{GS} = 0$
Gate Resistance	R_G	0.4	—	1.1	Ω	
Turn-On Delay Time	$t_{d(on)}$	—	10	—	ns	$V_{DD} = 16V, I_D = 15A$ $V_{GS} = 5.0V$ Clamped Inductive Load See Test Diagram Fig. 14
Drain Voltage Rise Time	t_{rV}	—	18	—		
Turn-Off Delay Time	$t_{d(off)}$	—	11	—		
Drain Voltage Fall Time	t_{fV}	—	3	—		
Input Capacitance	C_{iss}	—	1650	—	pF	$V_{DS} = 25V$
Output Capacitance	C_{oss}	—	650	—		$V_{GS} = 0$
Reverse Transfer Capacitance	C_{rss}	—	58	—		

Source-Drain Rating & Characteristics

Parameter	Symbol	Min	Typ	Max	Units	Conditions
Diode Forward Voltage*	V_{SD}	—	—	1.0	V	$I_S = 15A$ ②, $V_{GS} = 0V$
Reverse Recovery Charge ④	Q_{rr}	—	76	—	nC	$di/dt = 700A/\mu s$ $V_{DD} = 16V, V_{GS} = 0V, I_S = 15A$
Reverse Recovery Charge (with Parallel Schottky) ④	$Q_{rr(s)}$	—	67	—		$di/dt = 700A/\mu s$ (with 10BQ040) $V_{DD} = 16V, V_{GS} = 0V, I_S = 15A$

Notes:

- ① Repetitive rating; pulse width limited by max. junction temperature. ⑤ Calculated continuous current based on maximum allowable Junction temperature; switching and other losses will decrease RMS current capability; package limitation current = 20A.
- ② Pulse width $\leq 300 \mu s$; duty cycle $\leq 2\%$.
- ③ When mounted on 1 inch square copper board, $t < 10$ sec.
- ④ Typ = measured - Q_{oss}
- ⑥ R_{θ} is measured at T_J approximately at $90^\circ C$

*Devices are 100% tested to these parameters.

Power MOSFET Optimization for DC-DC Converters

While the IRLR8103V and IRLR8503 can and are being used in a variety of applications, they were designed and optimized for low voltage DC-DC conversion in a synchronous buck converter topology, specifically, microprocessor power applications. The IRLR8503 (Figure 1) was optimized for the control FET socket, while the IRLR8103V was optimized for the synchronous FET function.

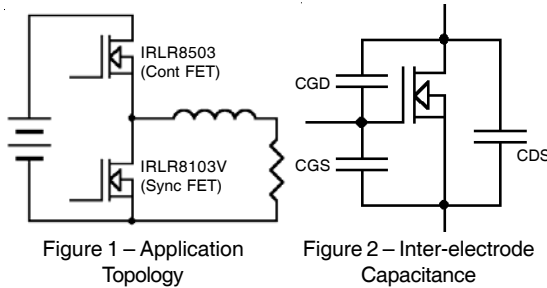

Because of the inter-electrode capacitance (Figure 2) of the Power MOSFET, specifying the $R_{DS(on)}$ of the device is not enough to ensure good performance. An optimization between $R_{DS(on)}$ and charge must be performed to insure the best performing MOSFET for a given application. Both die size and device architecture must be varied to achieve the minimum possible in-circuit losses. This is independently true for both control FET and synchronous FET. Unfortunately, the capacitances of a FET are non-linear and voltage dependent. Therefore, it is inconvenient to specify and use them effectively in switching power supply power loss estimations. This was well understood years ago and resulted in changing the emphasis from capacitance to gate charge on Power MOSFET data sheets.

Table 1 – Traditional Charge Parameters

Device Capacitance	Corresponding Charge Parameter
C_{GS}	Q_{GS}
$C_{GS} + C_{GD}$	Q_G
C_{GD}	Q_{GD}

International Rectifier has recently taken the industry a step further by specifying new charge parameters that are even more specific to DC-DC converter design (Table 2). In order to understand these parameters, it is best to start with the in-circuit waveforms in Figure 3 & Figure 4.

Table 2 – New Charge Parameters

New Charge Parameter	Description	Waveform
Q_{GS1}	Pre-Threshold Gate Charge	Figure 3
Q_{GS2}	Post-Threshold Gate Charge	
Q_{GCONT}	Control FET Total Q_G	
Q_{SWITCH}	Charge during control FET switching Combines Q_{GS2} and Q_{GD}	
Q_{OSS}	Output charge Charge supplied to C_{OSS} during the Q_{GD} period of control FET switching	Figure 5 Figure 6
Q_{Gsync}	Synchronous FET Total Q_G ($V_{DS} \leq 0$)	Figure 4

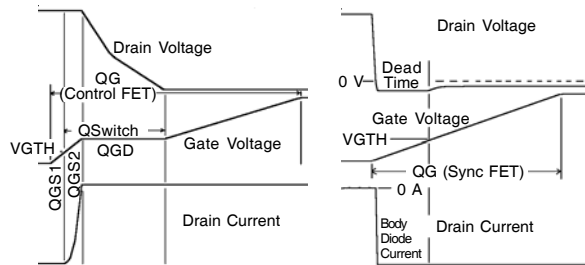

Figure 3 – Control FET Waveform

Figure 4 – Sync FET Waveform

The waveforms are broken into segments corresponding to charge parameters. These, in turn, correspond to discrete time segments of the switching waveform.

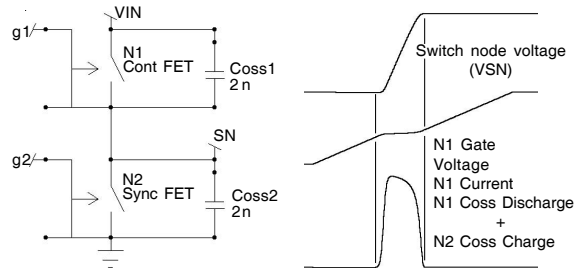

Figure 5 – Q_{OSS} Equivalent Circuit

Figure 6 – Q_{OSS} Waveforms

Losses may be broken into four categories: conduction loss, gate drive loss, switching loss, and output loss. The following simplified power loss equation is true for both MOSFETs in a synchronous buck converter:

$$P_{LOSS} = P_{CONDUCTION} + P_{GATE DRIVE} + P_{SWITCH} + P_{OUTPUT}$$

For the synchronous FET, the P_{SWITCH} term becomes virtually zero and is ignored.

Table 3 and Table 4 describes the event during the various charge segments and shows an approximation of losses during that period.

Table 3 – Control FET Losses

	Description	Segment Losses
Conduction Loss	Losses associated with MOSFET on time. I_{RMS} is a function of load current and duty cycle.	$P_{COND} = I_{RMS}^2 \times R_{DS(on)}$
Gate Drive Loss	Losses associated with charging and discharging the gate of the MOSFET every cycle. Use the control FET Q_G .	$P_{IN} = V_G \times Q_G \times f$
Switching Loss	Losses during the drain voltage and drain current transitions for every full cycle. Losses occur during the Q_{GS2} and Q_{GD} time period and can be simplified by using Q_{switch} .	$P_{QGS2} \approx V_{IN} \times I_L \times \frac{Q_{GS2}}{I_G} \times f$ $P_{QGD} \approx V_{IN} \times I_L \times \frac{Q_{GD}}{I_G} \times f$ $P_{SWITCH} \approx V_{IN} \times I_L \times \frac{Q_{SW}}{I_G} \times f$
Output Loss	Losses associated with the Q_{OSS} of the device every cycle when the control FET turns on. Losses are caused by both FETs, but are dissipated by the control FET.	$P_{OUTPUT} = \frac{Q_{OSS}}{2} \times V_{IN} \times F$

Table 4 – Synchronous FET Losses

	Description	Segment Losses
Conduction Loss	Losses associated with MOSFET on time. I_{RMS} is a function of load current and duty cycle.	$P_{COND} = I_{RMS}^2 \times R_{DS(on)}$
Gate Drive Loss	Losses associated with charging and discharging the gate of the MOSFET every cycle. Use the Sync FET Q_G .	$P_{IN} = V_G \times Q_G \times f$
Switching Loss	Generally small enough to ignore except at light loads when the current reverses in the output inductor. Under these conditions various light load power saving techniques are employed by the control IC to maintain switching losses to a negligible level.	$P_{SWITCH} \approx 0$
Output Loss	Losses associated with the Q_{OSS} of the device every cycle when the control FET turns on. They are caused by the synchronous FET, but are dissipated in the control FET.	$P_{OUTPUT} = \frac{Q_{OSS}}{2} \times V_{IN} \times f$

Typical PC Application

The IRLR8103V and the IRLR8503 are suitable for Synchronous Buck DC-DC Converters, and are optimized for use in next generation CPU applications. The IRLR8103V is primarily optimized for use as the low side synchronous FET (Q2) with low $R_{DS(on)}$ and high CdV/dt immunity. The IRLR8503 is primarily optimized for use as the high side control FET (Q1) with low combined Q_{sw} and $R_{DS(on)}$, but can also be used as a synchronous FET. The IRLR8503 is also tested for CdV/dt immunity, critical for the low side socket. The typical configuration in which these devices may be used in shown in Figure 7.

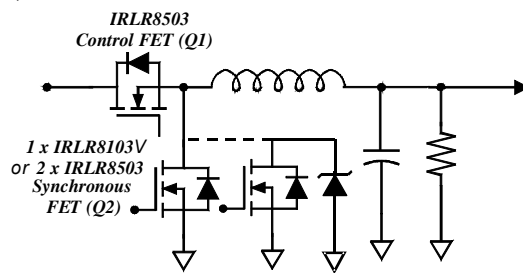

Figure 7. 2 & 3-FET solution for Synchronous Buck Topology.

Typical Characteristics
IRLR8503

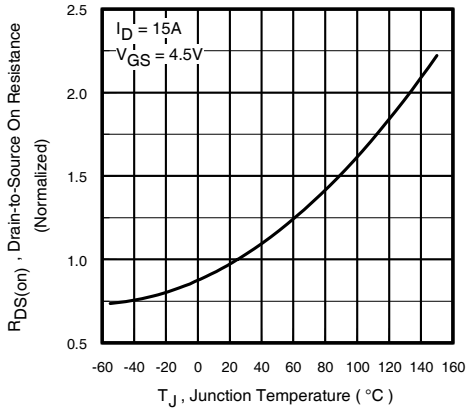

Figure 8. Normalized On-Resistance vs. Temperature

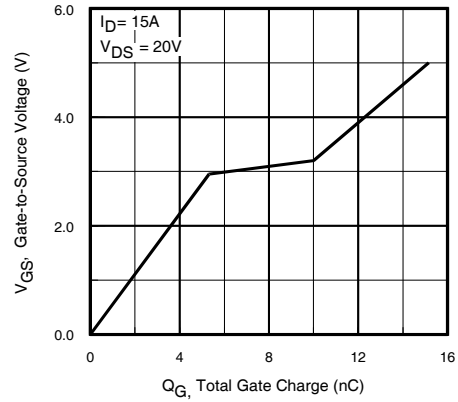

Figure 9. Gate-to-Source Voltage vs. Typical Gate Charge

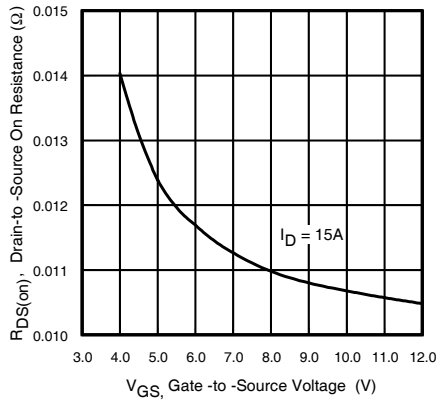

Figure 10. Typical R_{ds(on)} vs. Gate-to-Source Voltage

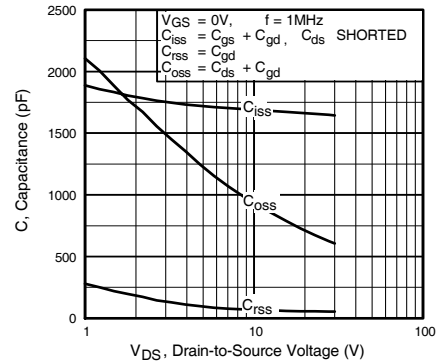

Figure 11. Typical Capacitance vs. Drain-to-Source Voltage

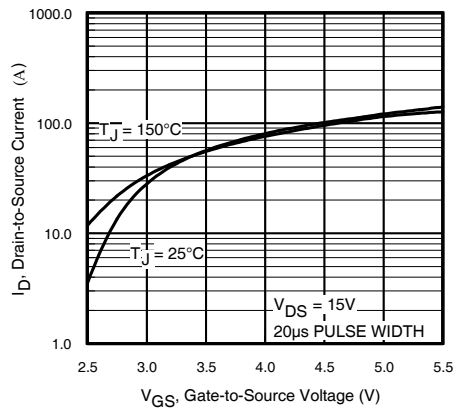
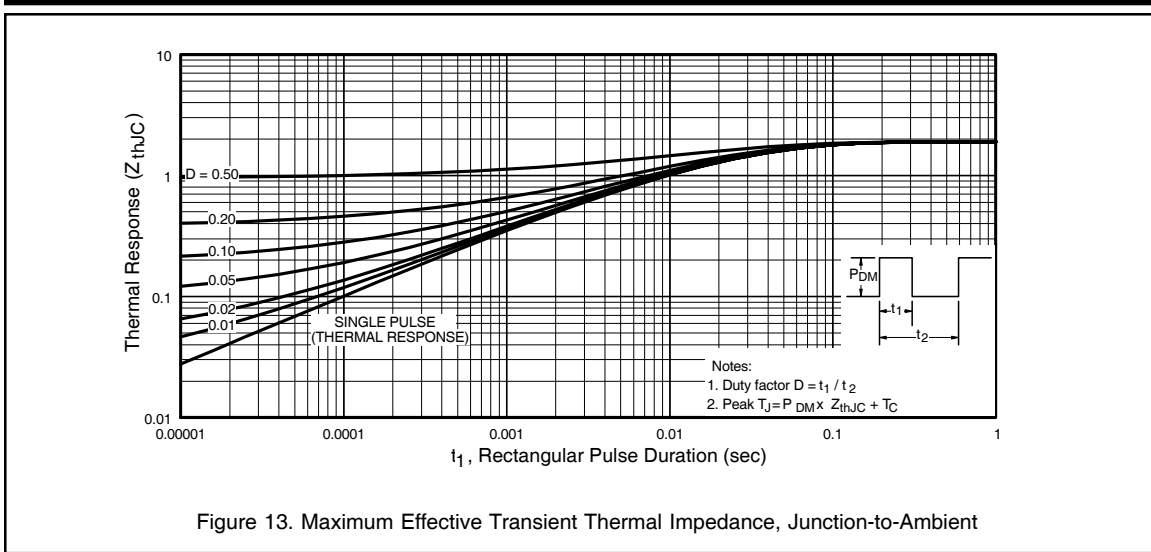

Figure 12. Typical Transfer Characteristics



Inductive Load Circuit

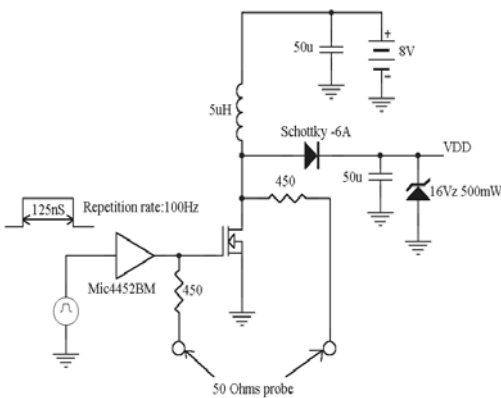

Figure 14. Clamped Inductive Load test diagram

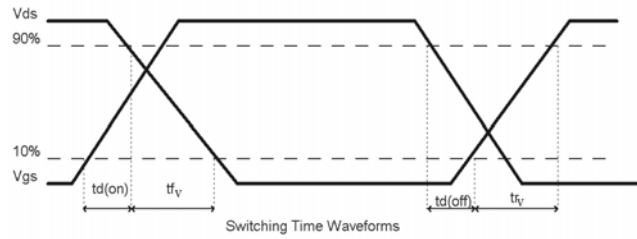
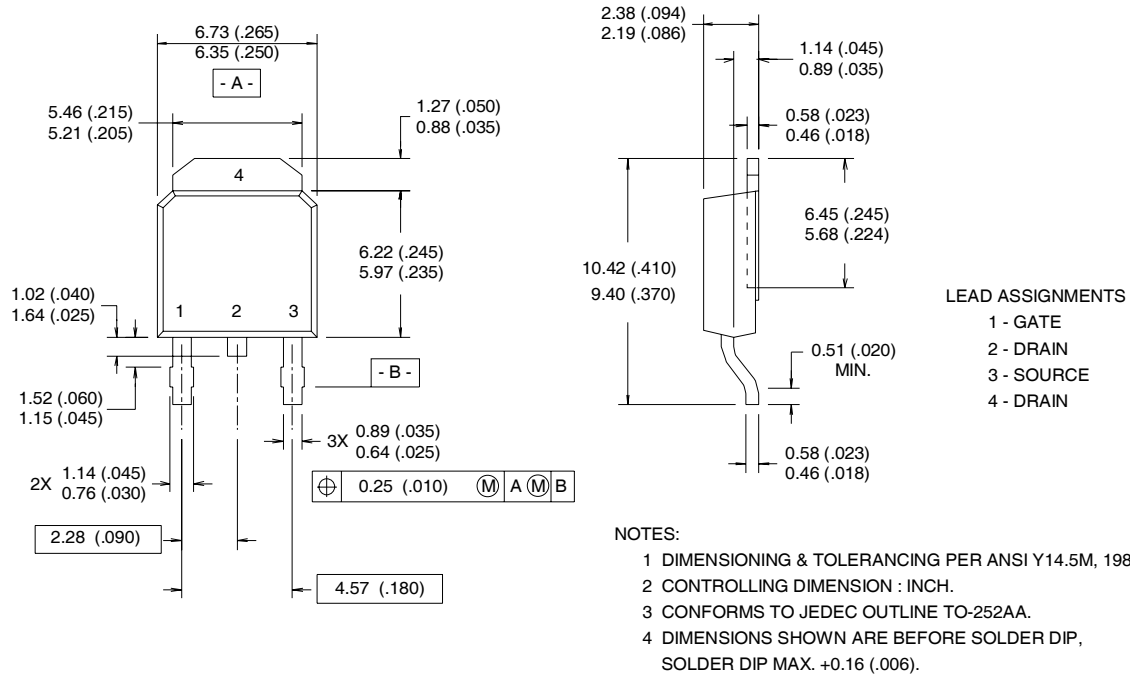

Figure 15. Switching waveform

D-Pak (TO-252AA) Package Outline

Dimensions are shown in millimeters (inches)



D-Pak (TO-252AA) Part Marking Information

EXAMPLE: THIS IS AN IRFR120
WITH ASSEMBLY
LOT CODE 1234
ASSEMBLED ON WW 16, 1999
IN THE ASSEMBLY LINE "A"

Note: "P" in assembly line
position indicates "Lead-Free"

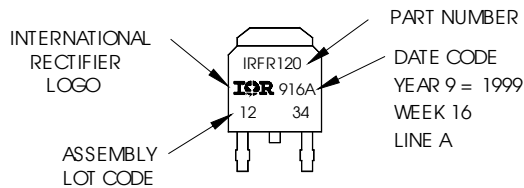

OR

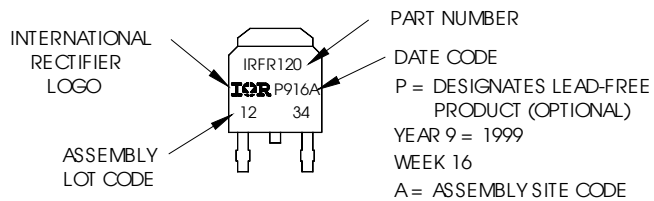

IRLR8503



Tape & Reel Information

TO-252AA

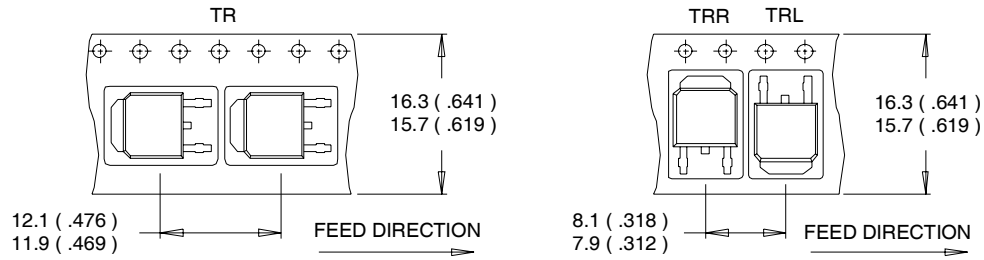

- NOTES :
1. CONTROLLING DIMENSION : MILLIMETER.
 2. ALL DIMENSIONS ARE SHOWN IN MILLIMETERS (INCHES).
 3. OUTLINE CONFORMS TO EIA-481 & EIA-541.

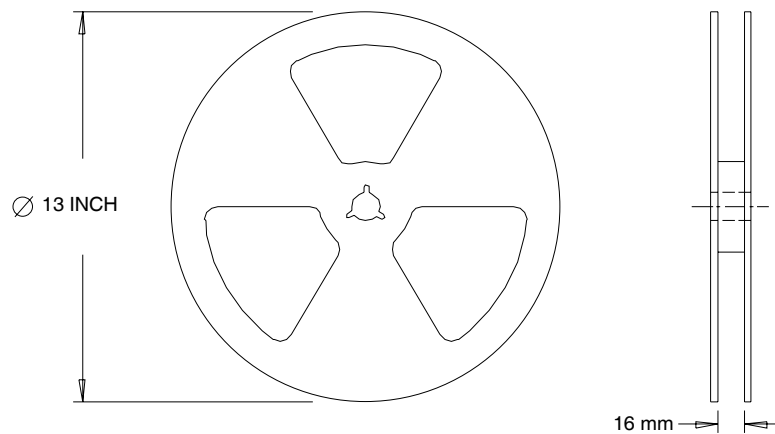

- NOTES :
1. OUTLINE CONFORMS TO EIA-481.

Data and specifications subject to change without notice.
This product has been designed and qualified for the commercial market.
Qualification Standards can be found on IR's Web site.



IR WORLD HEADQUARTERS: 233 Kansas St., El Segundo, California 90245, USA Tel: (310) 252-7105
TAC Fax: (310) 252-7903

Visit us at www.irf.com for sales contact information. 5/05

www.irf.com

Note: For the most current drawings please refer to the IR website at:
<http://www.irf.com/package/>