

DATA SHEET

DSG9500-000: Planar Beam-Lead PIN Diode

Applications

- Designed for switching applications

Features

- Low capacitance
- Low resistance
- Fast switching
- Oxide-nitride passivated
- Durable construction
- High voltage
- Lead (Pb)-free, RoHS-compliant, and Green™



Description

The DSG9500-000 silicon planar beam-lead PIN diode is designed for low resistance, low capacitance and fast switching time.

The oxide-nitride passivation layers protect the diode junction to provide excellent reliability and stable electrical performance, especially when the diode is housed in a hermetically sealed assembly to further protect the junction from moisture.

The DSG9500-000 is designed for microstrip or stripline circuits and for circuits requiring high isolation from a series-mounted diode such as broadband multithrow switches, phase shifters, limiters, attenuators and modulators.

NEW



Skyworks Green™ products are RoHS (Restriction of Hazardous Substances)-compliant, conform to the EIA/EICTA/JEITA Joint Industry Guide (JIG) Level A guidelines, are halogen free according to IEC-61249-2-21, and contain <1,000 ppm antimony trioxide in polymeric materials.

Absolute Maximum Ratings

Characteristic	Value
Operating temperature	-65 °C to +150 °C
Storage temperature	-65 °C to +200 °C
Power dissipation (derate linearly to zero @ 175 °C)	250 mW
Typical lead strength	8 grams pull
Reverse voltage	100 V

Performance is guaranteed only under the conditions listed in the specifications table and is not guaranteed under the full range(s) described by the Absolute Maximum Ratings. Exceeding any of the absolute maximum/minimum specifications may result in permanent damage to the device and will void the warranty.

CAUTION: *Although these devices are designed to be robust, ESD (Electrostatic Discharge) can cause permanent damage. Static charges may easily produce potentials of several kilovolts on the human body or equipment, which can discharge without detection. Industry-standard ESD precautions must be employed at all times.*

Electrical Specifications

Part Number	Voltage Rating ⁽¹⁾ (V)	C _T 50 V, 1 MHz (pF)	R _S 50 mA, 100 MHz (Ω)	T _L I _F = 10 mA (ns)	RF Switching Time T _S (ns) ⁽²⁾	Outline Drawing
		Max.	Max.	Typ.	Typ.	
DSG9500-000	100	0.025	4	250	25	169-001

1. Reverse current is specified at 10 μA maximum at the voltage rating. This voltage should not be exceeded.
 2. T_S measured from RF transition, 90% to 10%, in series configuration.

Performance Data for DSG9500-000

Figures 1 and 2 show a single pole double throw 1–18 GHz switch. These diodes are mounted on Alumina, Duroid, or Teflon fiberglass 50 Ω microstrip circuits. Typical bonding methods include thermal compression bonding, parallel gap welding, and soldering.

SPDT isolation curves are shown in Figure 3, and insertion loss in Figures 4 and 5. With proper transitions and bias circuits, VSWR is better than 2.0 to 1 through 18 GHz.

Switching Considerations

The typical minority carrier lifetime of the DSG9500 diodes is 250 ns. With suitable drivers, the individual diodes can be switched from high impedance (off) to low R_S (on) in about 10 ns.

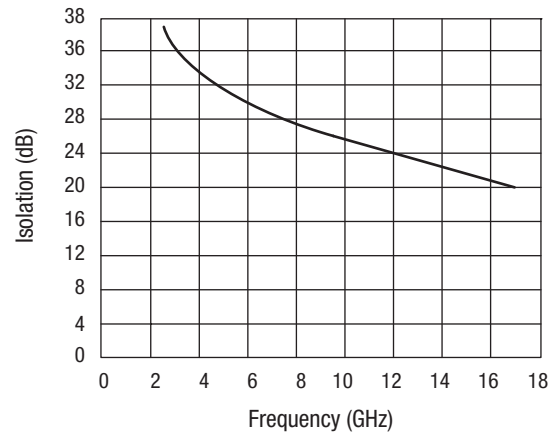

Figure 3. Isolation vs. Frequency, SPDT

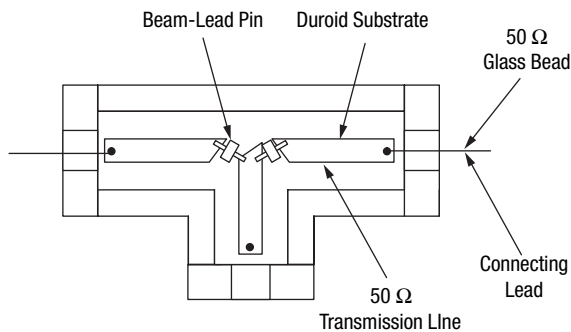

Figure 1. Typical SPDT Circuit Arrangement

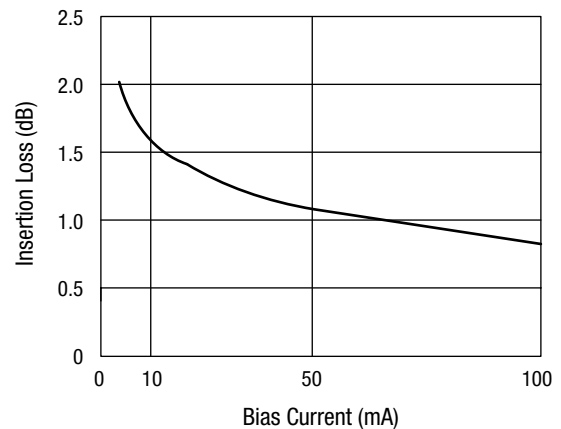

Figure 4. Diode Insertion Loss vs. Bias, SPST 18 GHz

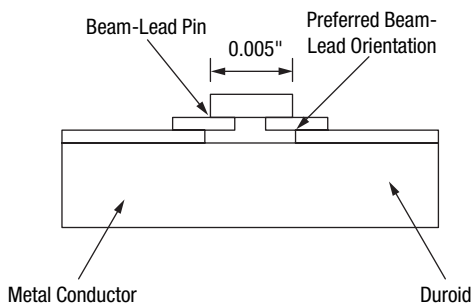

Figure 2. Typical Beam-Lead Mounting

Power Handling for DSG9500-000

Beam-lead diodes are not suitable for high-power operation because of high internal thermal impedance of about 600 °C/W.

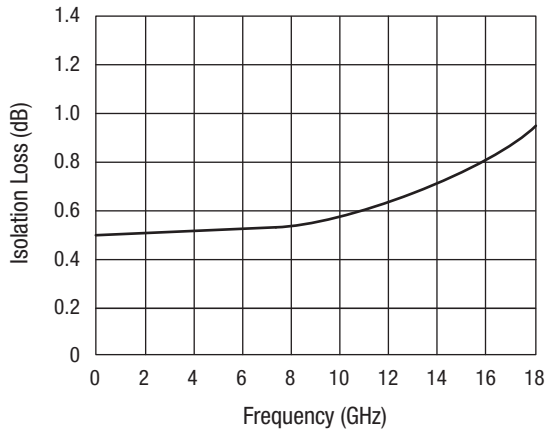

Figure 5. Diode Insertion Loss vs. Frequency, SPST, I_F = 50 mA

With maximum CW power dissipation of 250 mW, the DSG9500-000 diodes are normally rated at 2 W incident CW with linear derating between 25 °C and 150 °C.

For pulsed operation, the total RF plus bias voltage must not exceed the rated breakdown. Skyworks has made high-power tests at 1 GHz with 1 μs pulses, 0.001 duty, with 100 V diodes. With 50 mA forward bias, there is no increase in insertion loss over the 0 dBm level with a peak power input of 50 W. In the open state, reverse bias voltage is required to minimize distortion, which may decrease isolation and cause possible failure. Figure 6 shows allowed peak power versus reverse bias at 1 GHz.

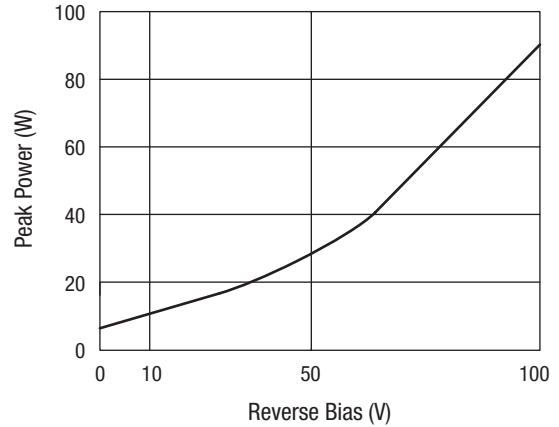
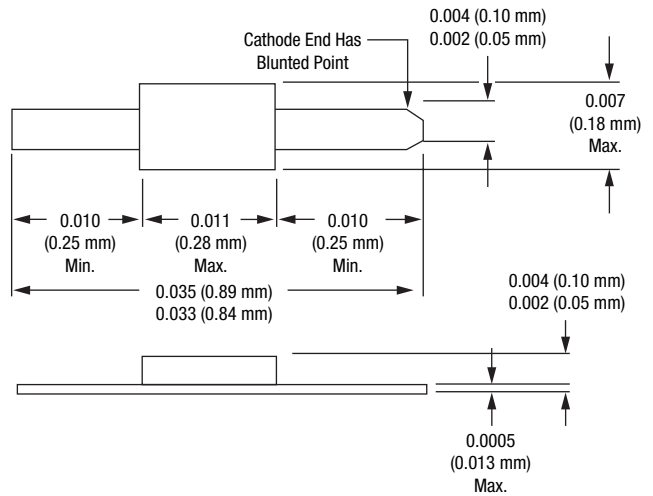

Figure 6. Peak Power Handling, SPST 1 GHz

169-001



Beam-Lead Diodes

Handling

Due to their small size, beam-lead devices are fragile and should be handled with extreme care. The individual plastic packages should be handled and opened carefully, so that no undue mechanical strain is applied to the packaged device. It is recommended that the beam-lead devices be handled through use of a vacuum pencil using an appropriate size vacuum needle or a pointed wooden stick such as a sharpened Q-tip or match stick. The device will adhere to the point and can easily be removed from the container and positioned accurately for bonding without damage. Such handling should be done under a binocular microscope with magnification in the range of 20X to 30X.

Special handling precautions are also required to avoid electrical damage, such as static discharge.

Bonding

The DSG9500-000 can best be bonded to substrates by means of thermocompression bonding. Essentially this type of bonding involves pressing the gold beam of the device against the gold-plated metalized substrate under proper conditions of heat and pressure so that a metallurgical bond joint between the two occurs.

Procedure

The beam-lead devices to be bonded should be placed on a clean, hard surface such as a microscope slide. It is recommended that the beam side of the device be down so that this side will be toward the substrate when bonded. The device can be picked up by pressing lightly against one beam with the heated tip. The substrate can then be appropriately positioned under the tip and the device brought down against the substrate, with proper pressure applied by means of the weld head.

A bonding tip temperature in the 350 °C to 450 °C range is recommended along with a bonding force of 50 to 70 grams. The bonding time is in the range of 2 to 3 seconds. Optimum bonding conditions should be determined by trial and error to compensate for slight variations in the condition of the substrate, bonding tip, and the type of device being bonded.

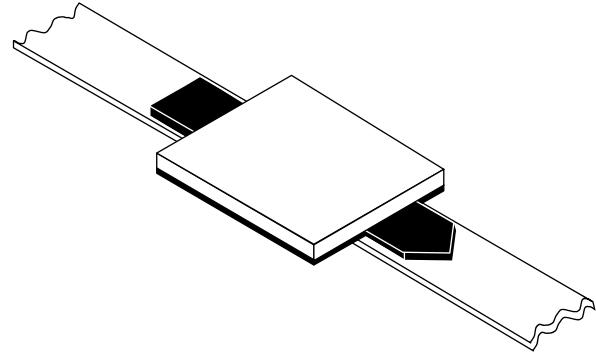

Equipment

The heat and pressure are obtained through use of a silicon carbide bonding tip with a radius of two to three mils. Such an item is available from several commercial sources. In order to supply the required tip-travel and apply proper pressure, a standard miniature weld head can be used. Also available is a heated wedge shank which is held by the weld head and in turn holds the tip and supplies heat to it. The wedge shank is heated by means of a simple AC power supply or a pulse-type heated tool.

Substrate

For optimum bonding, a gold-plated surface at least 100-micro-inches thick is necessary. Although it is possible to bond to relatively soft metalized substrate material such as epoxy-fiber-glass, etc., optimum bonding occurs when a hard material such as ceramic can be used.

Quality

If a good bond has been obtained, it is impossible to separate the beam-lead device from the metalized substrate without damage. If the device is destructively removed, the beam will tear away, leaving the bonded portion attached to the substrate.

Beam-Lead Packaging

The DSG9500-000 is shipped in 2" x 2" black gel packs. The beam-leads are mounted on the gel, and the devices are covered with a piece of lint-free release paper, on top of which is placed a piece of conductive foam.

Copyright © 2002, 2003, 2004, 2005, 2006, 2007, 2008, Skyworks Solutions, Inc. All Rights Reserved.

Information in this document is provided in connection with Skyworks Solutions, Inc. ("Skyworks") products or services. These materials, including the information contained herein, are provided by Skyworks as a service to its customers and may be used for informational purposes only by the customer. Skyworks assumes no responsibility for errors or omissions in these materials or the information contained herein. Skyworks may change its documentation, products, services, specifications or product descriptions at any time, without notice. Skyworks makes no commitment to update the materials or information and shall have no responsibility whatsoever for conflicts, incompatibilities, or other difficulties arising from any future changes.

No license, whether express, implied, by estoppel or otherwise, is granted to any intellectual property rights by this document. Skyworks assumes no liability for any materials, products or information provided hereunder, including the sale, distribution, reproduction or use of Skyworks products, information or materials, except as may be provided in Skyworks Terms and Conditions of Sale.

THE MATERIALS, PRODUCTS AND INFORMATION ARE PROVIDED "AS IS" WITHOUT WARRANTY OF ANY KIND, WHETHER EXPRESS, IMPLIED, STATUTORY, OR OTHERWISE, INCLUDING FITNESS FOR A PARTICULAR PURPOSE OR USE, MERCHANTABILITY, PERFORMANCE, QUALITY OR NON-INFRINGEMENT OF ANY INTELLECTUAL PROPERTY RIGHT; ALL SUCH WARRANTIES ARE HEREBY EXPRESSLY DISCLAIMED. SKYWORKS DOES NOT WARRANT THE ACCURACY OR COMPLETENESS OF THE INFORMATION, TEXT, GRAPHICS OR OTHER ITEMS CONTAINED WITHIN THESE MATERIALS. SKYWORKS SHALL NOT BE LIABLE FOR ANY DAMAGES, INCLUDING BUT NOT LIMITED TO ANY SPECIAL, INDIRECT, INCIDENTAL, STATUTORY, OR CONSEQUENTIAL DAMAGES, INCLUDING WITHOUT LIMITATION, LOST REVENUES OR LOST PROFITS THAT MAY RESULT FROM THE USE OF THE MATERIALS OR INFORMATION, WHETHER OR NOT THE RECIPIENT OF MATERIALS HAS BEEN ADVISED OF THE POSSIBILITY OF SUCH DAMAGE.

Skyworks products are not intended for use in medical, lifesaving or life-sustaining applications, or other equipment in which the failure of the Skyworks products could lead to personal injury, death, physical or environmental damage. Skyworks customers using or selling Skyworks products for use in such applications do so at their own risk and agree to fully indemnify Skyworks for any damages resulting from such improper use or sale.

Customers are responsible for their products and applications using Skyworks products, which may deviate from published specifications as a result of design defects, errors, or operation of products outside of published parameters or design specifications. Customers should include design and operating safeguards to minimize these and other risks. Skyworks assumes no liability for applications assistance, customer product design, or damage to any equipment resulting from the use of Skyworks products outside of stated published specifications or parameters.

Skyworks, the Skyworks symbol, and "Breakthrough Simplicity" are trademarks or registered trademarks of Skyworks Solutions, Inc., in the United States and other countries. Third-party brands and names are for identification purposes only, and are the property of their respective owners. Additional information, including relevant terms and conditions, posted at www.skyworksinc.com, are incorporated by reference.