

# XPT™ 600V IGBTs GenX3™ w/ Diode

# IXXK100N60C3H1 IXXX100N60C3H1

$V_{CES} = 600V$   
 $I_{C90} = 100A$   
 $V_{CE(sat)} \leq 2.20V$   
 $t_{fi(typ)} = 75ns$

Extreme Light Punch Through  
IGBT for 20-60kHz Switching

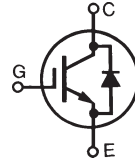

Symbol	Test Conditions	Maximum Ratings	
$V_{CES}$	$T_J = 25^\circ C$ to $150^\circ C$	600	V
$V_{CGR}$	$T_J = 25^\circ C$ to $150^\circ C$ , $R_{GE} = 1M\Omega$	600	V
$V_{GES}$	Continuous	$\pm 20$	V
$V_{GEM}$	Transient	$\pm 30$	V
$I_{C25}$	$T_C = 25^\circ C$ (Chip Capability)	170	A
$I_{LRMS}$	Terminal Current Limit	120	A
$I_{C90}$	$T_C = 90^\circ C$	100	A
$I_{F110}$	$T_C = 110^\circ C$	65	A
$I_{CM}$	$T_C = 25^\circ C$ , 1ms	340	A
$I_A$	$T_C = 25^\circ C$	50	A
$E_{AS}$	$T_C = 25^\circ C$	600	mJ
<b>SSOA</b> <b>(RBSOA)</b>	$V_{GE} = 15V$ , $T_{VJ} = 150^\circ C$ , $R_G = 2\Omega$ Clamped Inductive Load	$I_{CM} = 200$ @ $V_{CE} \leq V_{CES}$	A
$t_{sc}$ <b>(SCSOA)</b>	$V_{GE} = 15V$ , $V_{CE} = 360V$ , $T_J = 150^\circ C$ $R_G = 10\Omega$ , Non Repetitive	10	$\mu s$
$P_C$	$T_C = 25^\circ C$	695	W
$T_J$		-55 ... +150	$^\circ C$
$T_{JM}$		150	$^\circ C$
$T_{stg}$		-55 ... +150	$^\circ C$
$T_L$	Maximum Lead Temperature for Soldering	300	$^\circ C$
$T_{SOLD}$	1.6 mm (0.062in.) from Case for 10s	260	$^\circ C$
$M_d$	Mounting Torque (TO-264)	1.13/10	Nm/lb.in.
$F_c$	Mounting Force (PLUS247)	20..120 /4.5..27	N/lb.
<b>Weight</b>	TO-264	10	g
	PLUS247	6	g

TO-264 (IXXK)

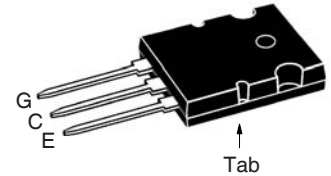

PLUS247 (IXXX)

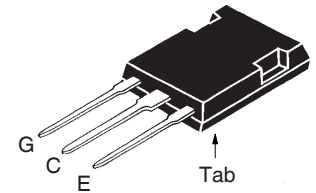

G = Gate                      E = Emitter  
 C = Collector                Tab = Collector

## Features

- International Standard Packages
- Optimized for 20-60kHz Switching
- Square RBSOA
- Avalanche Rated
- Short Circuit Capability
- Anti-Parallel Ultra Fast Diode
- High Current Handling Capability

## Advantages

- High Power Density
- Low Gate Drive Requirement

## Applications

- Power Inverters
- UPS
- Motor Drives
- SMPS
- PFC Circuits
- Battery Chargers
- Welding Machines
- Lamp Ballasts

Symbol	Test Conditions ( $T_J = 25^\circ C$ , Unless Otherwise Specified)	Characteristic Values		
		Min.	Typ.	Max.
$BV_{CES}$	$I_C = 250\mu A$ , $V_{GE} = 0V$	600		V
$V_{GE(th)}$	$I_C = 250\mu A$ , $V_{CE} = V_{GE}$	3.0		5.5 V
$I_{CES}$	$V_{CE} = V_{CES}$ , $V_{GE} = 0V$ $T_J = 125^\circ C$			50 $\mu A$ 4 mA
$I_{GES}$	$V_{CE} = 0V$ , $V_{GE} = \pm 20V$			$\pm 100$ nA
$V_{CE(sat)}$	$I_C = 70A$ , $V_{GE} = 15V$ , Note 1 $T_J = 150^\circ C$	1.68 1.97		2.20 V V

**Symbol Test Conditions**
 $(T_J = 25^\circ\text{C Unless Otherwise Specified})$ 
**Characteristic Values**

		Min.	Typ.	Max.	
$g_{fs}$	$I_C = 60\text{A}, V_{CE} = 10\text{V}, \text{Note 1}$	22	40		S
$C_{ies}$	$V_{CE} = 25\text{V}, V_{GE} = 0\text{V}, f = 1\text{MHz}$		4810		pF
$C_{oes}$			455		pF
$C_{res}$				80	
$Q_{g(on)}$	$I_C = 70\text{A}, V_{GE} = 15\text{V}, V_{CE} = 0.5 \cdot V_{CES}$		150		nC
$Q_{ge}$			34		nC
$Q_{gc}$			60		nC
$t_{d(on)}$	<b>Inductive load, <math>T_J = 25^\circ\text{C}</math></b> $I_C = 70\text{A}, V_{GE} = 15\text{V}$ $V_{CE} = 360\text{V}, R_G = 2\Omega$ Note 2		30		ns
$t_{ri}$			70		ns
$E_{on}$			2.00		mJ
$t_{d(off)}$			90		ns
$t_{fi}$			75		ns
$E_{off}$			0.95	1.40	mJ
$t_{d(on)}$	<b>Inductive load, <math>T_J = 150^\circ\text{C}</math></b> $I_C = 70\text{A}, V_{GE} = 15\text{V}$ $V_{CE} = 360\text{V}, R_G = 2\Omega$ Note 2		30		ns
$t_{ri}$			65		ns
$E_{on}$			3.00		mJ
$t_{d(off)}$			105		ns
$t_{fi}$			115		ns
$E_{off}$			1.40		mJ
$R_{thJC}$				0.18	$^\circ\text{C/W}$
$R_{thCS}$		0.15			$^\circ\text{C/W}$

**Reverse Diode (FRED)**
**Symbol Test Conditions**
 $(T_J = 25^\circ\text{C Unless Otherwise Specified})$ 
**Characteristic Values**

		Min.	Typ.	Max.	
$V_F$	$I_F = 60\text{A}, V_{GE} = 0\text{V}, \text{Note 1}$		1.6	2.0	V
	$T_J = 150^\circ\text{C}$		1.4	1.8	V
$I_{RM}$	$I_F = 60\text{A}, V_{GE} = 0\text{V},$ $-di_F/dt = 200\text{A}/\mu\text{s}, V_R = 300\text{V}$		8.3		A
$t_{rr}$		$T_J = 100^\circ\text{C}$		140	
$R_{thJC}$				0.30	$^\circ\text{C/W}$

**Notes:**

1. Pulse test,  $t \leq 300\mu\text{s}$ , duty cycle,  $d \leq 2\%$ .
2. Switching times & energy losses may increase for higher  $V_{CE}(\text{clamp})$ ,  $T_J$  or  $R_G$ .

IXYS Reserves the Right to Change Limits, Test Conditions, and Dimensions.

IXYS MOSFETs and IGBTs are covered by one or more of the following U.S. patents:	4,835,592	4,931,844	5,049,961	5,237,481	6,162,665	6,404,065 B1	6,683,344	6,727,585	7,005,734 B2	7,157,338B2
	4,860,072	5,017,508	5,063,307	5,381,025	6,259,123 B1	6,534,343	6,710,405 B2	6,759,692	7,063,975 B2	
	4,881,106	5,034,796	5,187,117	5,486,715	6,306,728 B1	6,583,505	6,710,463	6,771,478 B2	7,071,537	

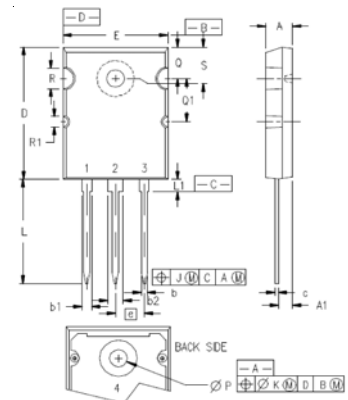
**TO-264 Outline**

 Terminals: 1 = Gate  
 2,4 = Collector  
 3 = Emitter

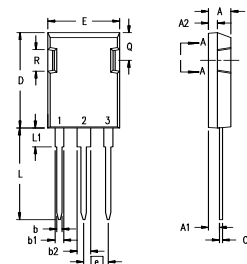
SYM	INCHES		MILLIMETERS	
	MIN	MAX	MIN	MAX
A	.185	.209	4.70	5.31
A1	.102	.118	2.59	3.00
b	.037	.055	0.94	1.40
b1	.087	.102	2.21	2.59
b2	.110	.126	2.79	3.20
c	.017	.029	0.43	0.74
D	1.007	1.047	25.58	26.59
E	.760	.799	19.30	20.29
e	.215 BSC		5.46 BSC	
J	.000	.010	0.00	0.25
K	.000	.010	0.00	0.25
L	.779	.842	19.79	21.39
L1	.087	.102	2.21	2.59
ØP	.122	.138	3.10	3.51
Q	.240	.256	6.10	6.50
Q1	.330	.346	8.38	8.79
ØR	.155	.187	3.94	4.75
ØR1	.085	.093	2.16	2.36
S	.243	.253	6.17	6.43

**PLUS247™ Outline**

 Terminals: 1 - Gate  
 2 - Collector  
 3 - Emitter

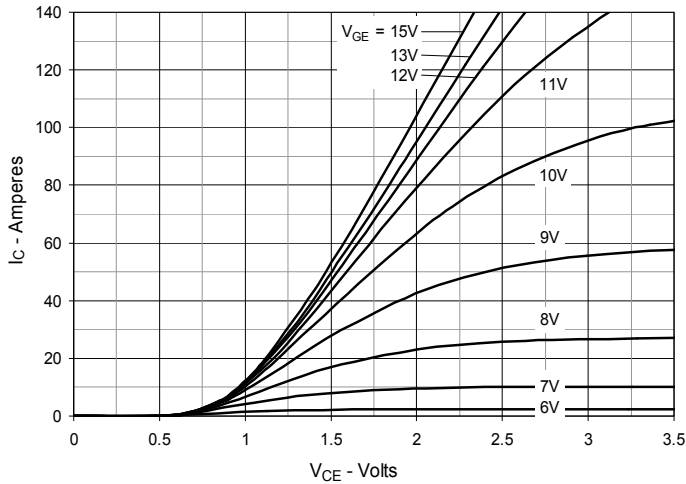
Dim.	Millimeter		Inches	
	Min.	Max.	Min.	Max.
A	4.83	5.21	.190	.205
A <sub>1</sub>	2.29	2.54	.090	.100
A <sub>2</sub>	1.91	2.16	.075	.085
b	1.14	1.40	.045	.055
b <sub>1</sub>	1.91	2.13	.075	.084
b <sub>2</sub>	2.92	3.12	.115	.123
C	0.61	0.80	.024	.031
D	20.80	21.34	.819	.840
E	15.75	16.13	.620	.635
e	5.45 BSC		.215 BSC	
L	19.81	20.32	.780	.800
L1	3.81	4.32	.150	.170
Q	5.59	6.20	.220	0.244
R	4.32	4.83	.170	.190

**Fig. 1. Output Characteristics @  $T_J = 25^\circ\text{C}$**

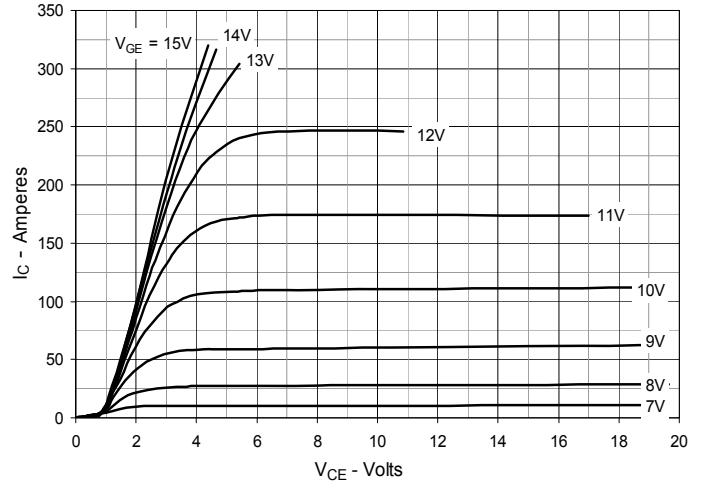

**Fig. 2. Extended Output Characteristics @  $T_J = 25^\circ\text{C}$**



**Fig. 3. Output Characteristics @  $T_J = 150^\circ\text{C}$**

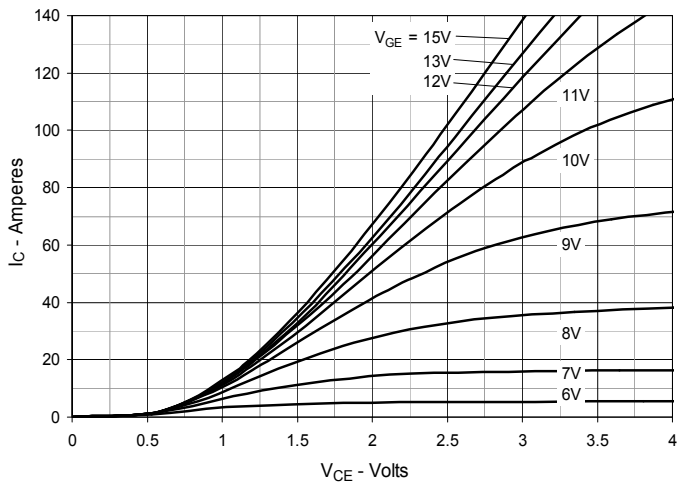

**Fig. 4. Dependence of  $V_{CE(sat)}$  on Junction Temperature**

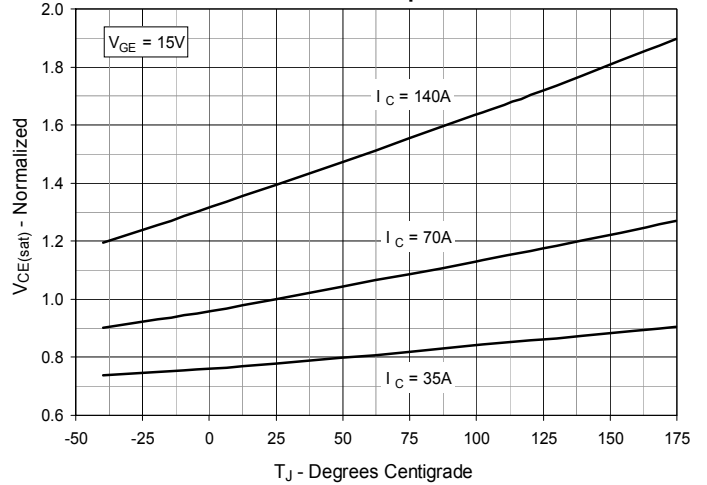

**Fig. 5. Collector-to-Emitter Voltage vs. Gate-to-Emitter Voltage**

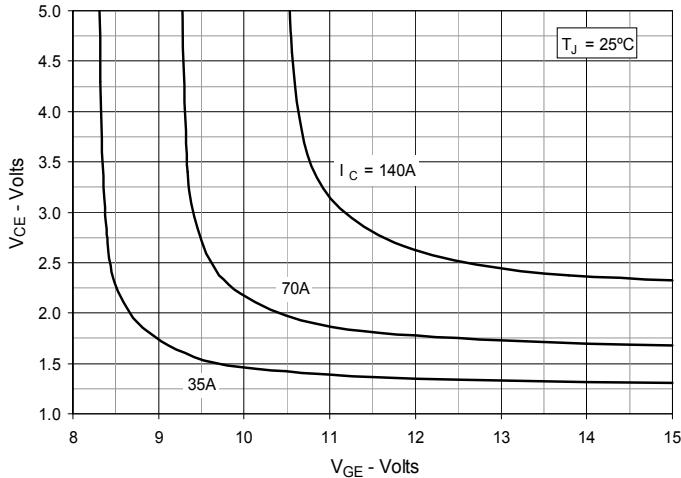

**Fig. 6. Input Admittance**

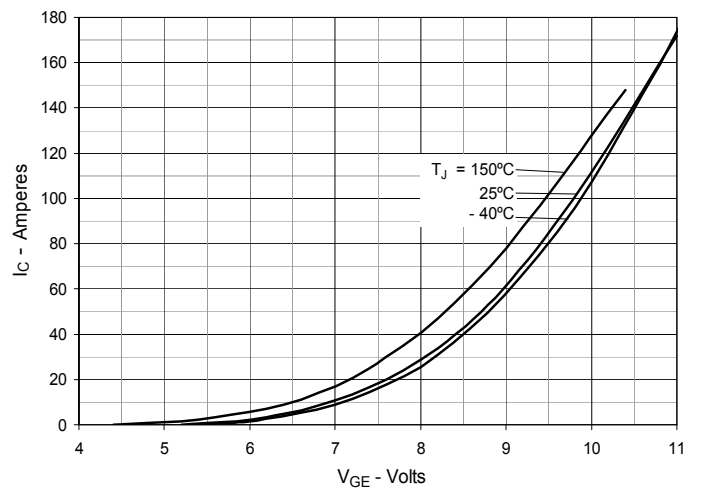

**Fig. 7. Transconductance**

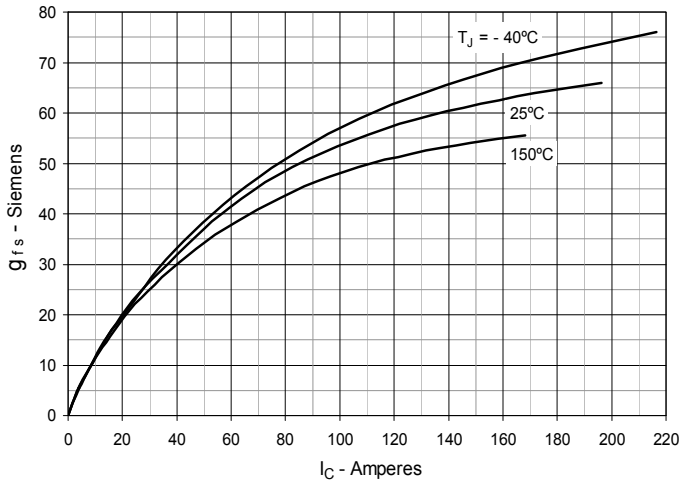

**Fig. 8. Gate Charge**

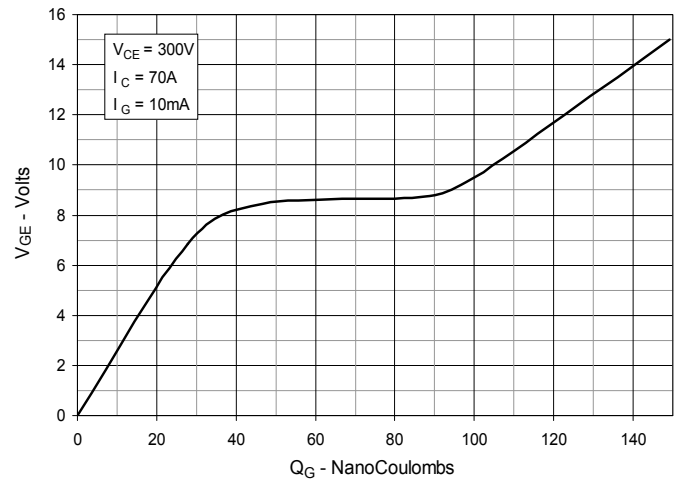

**Fig. 9. Capacitance**

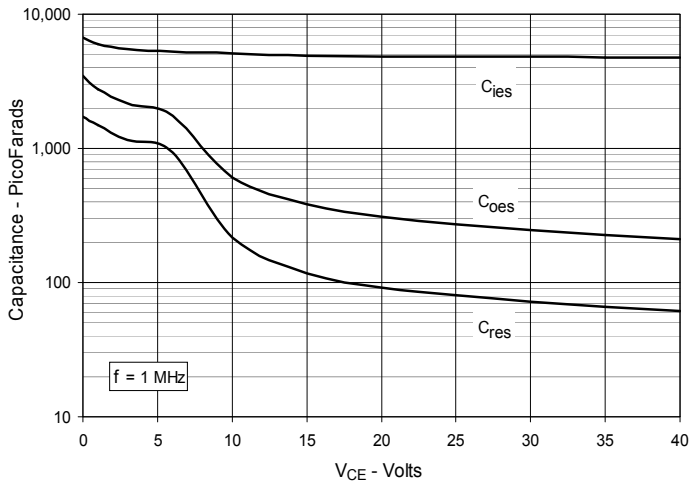

**Fig. 10. Reverse-Bias Safe Operating Area**

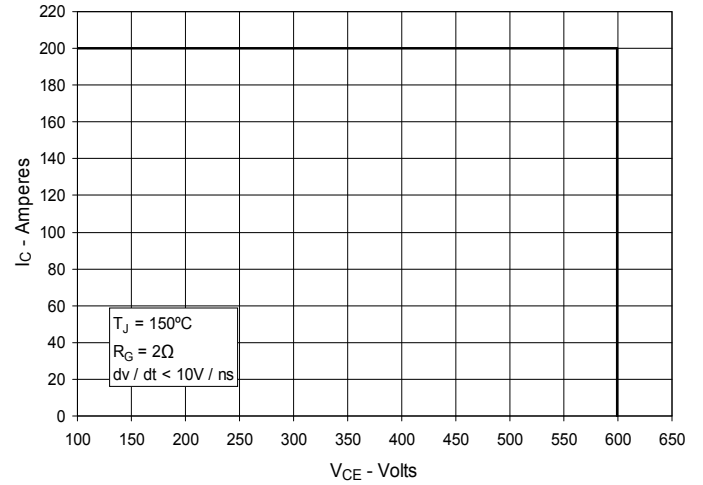

**Fig. 11. Forward-Bias Safe Operating Area**

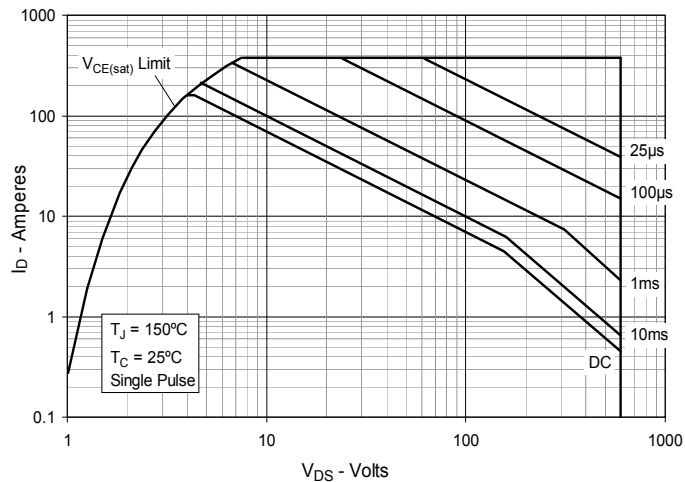

**Fig. 12. Maximum Transient Thermal Impedance**

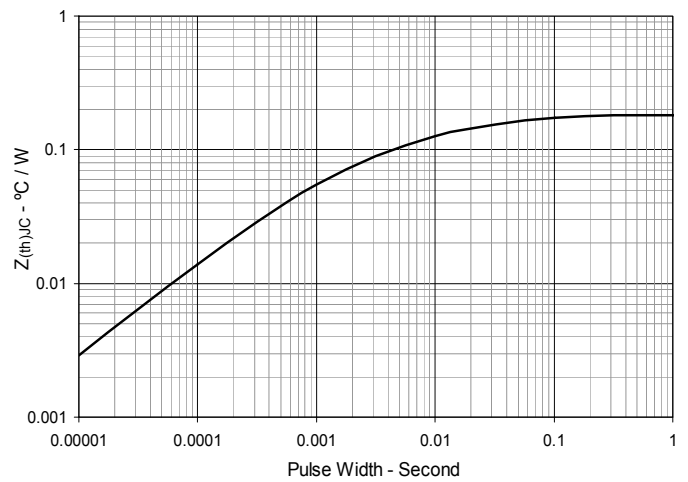

**Fig. 13. Inductive Switching Energy Loss vs. Gate Resistance**

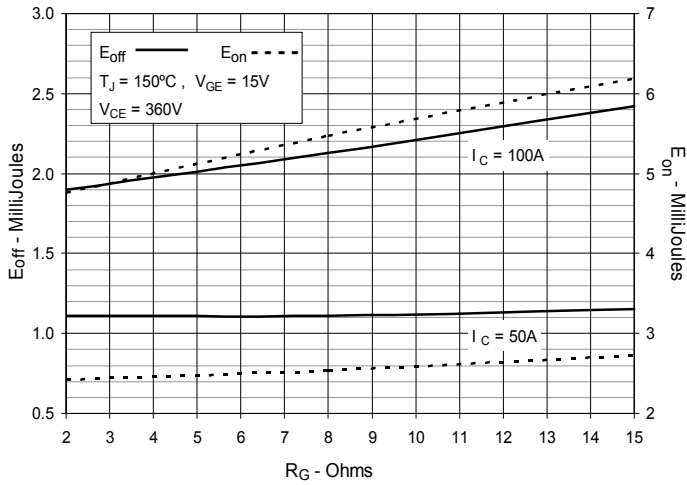

**Fig. 14. Inductive Switching Energy Loss vs. Collector Current**

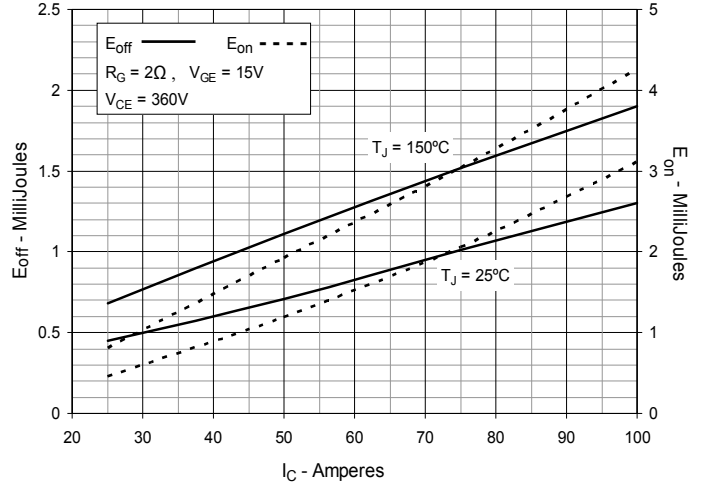

**Fig. 15. Inductive Switching Energy Loss vs. Junction Temperature**

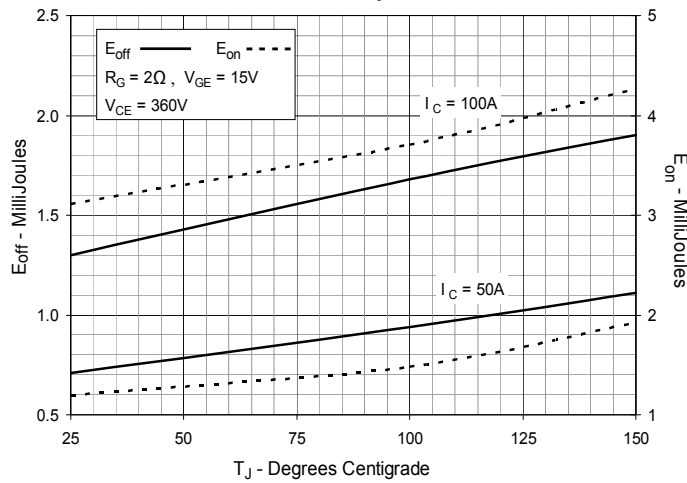

**Fig. 16. Inductive Turn-off Switching Times vs. Gate Resistance**

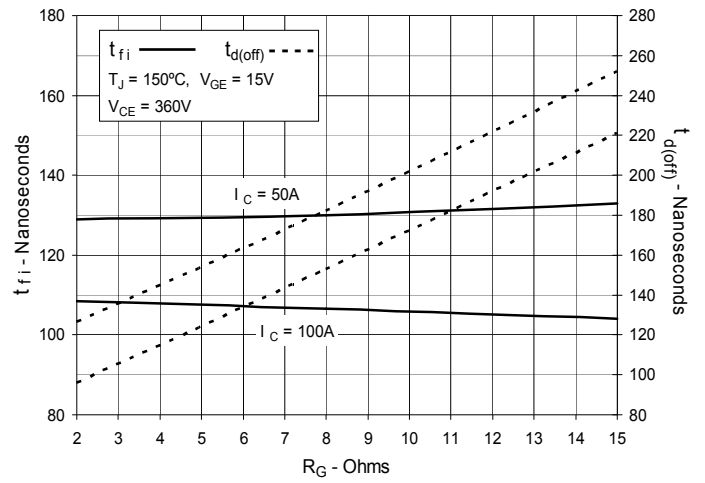

**Fig. 17. Inductive Turn-off Switching Times vs. Collector Current**

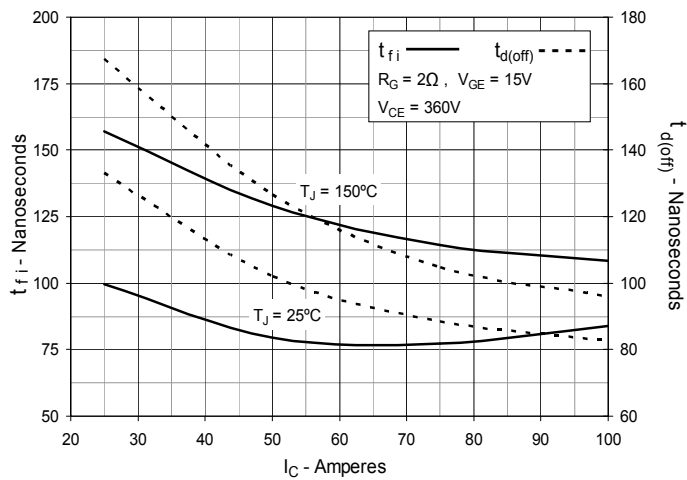

**Fig. 18. Inductive Turn-off Switching Times vs. Junction Temperature**

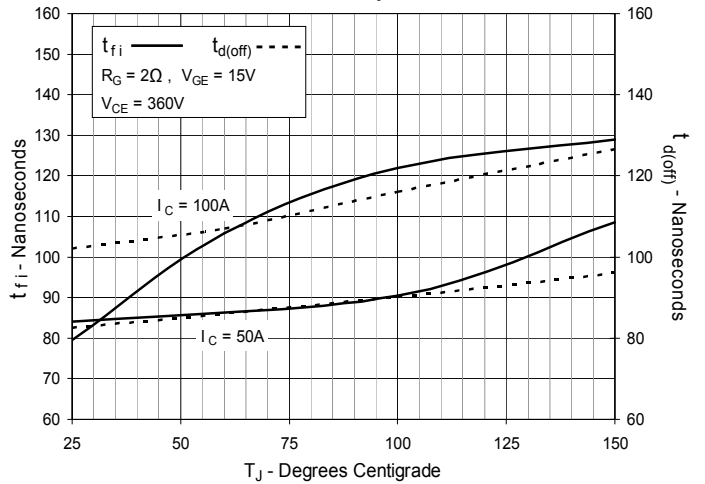

**Fig. 19. Inductive Turn-on Switching Times vs. Gate Resistance**

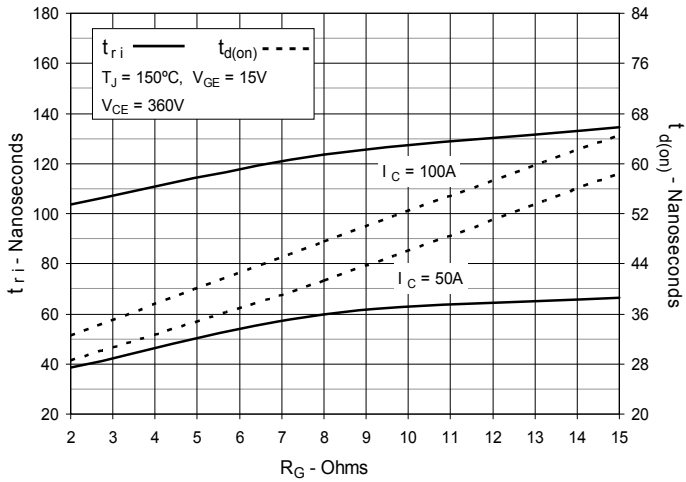

**Fig. 20. Inductive Turn-on Switching Times vs. Collector Current**

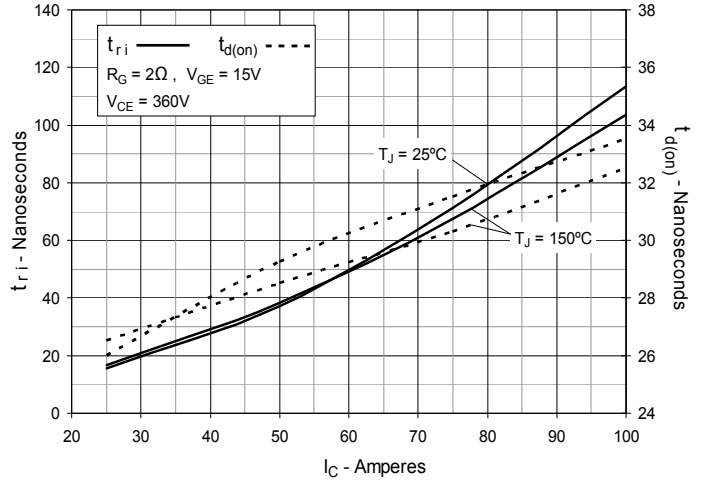

**Fig. 21. Inductive Turn-on Switching Times vs. Junction Temperature**

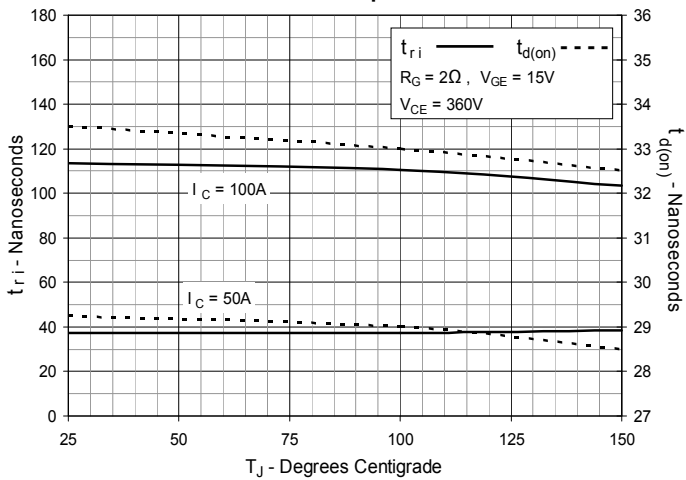

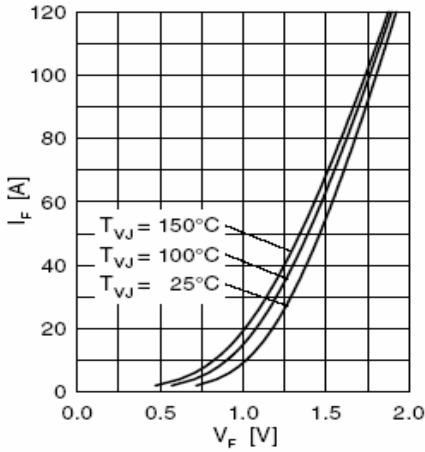

Fig. 22. Forward Current  $I_F$  Versus  $V_F$

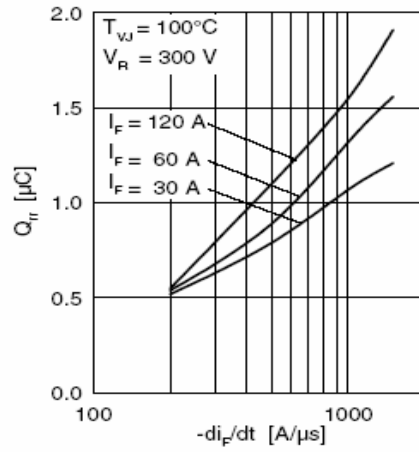

Fig. 23. Reverse Recovery Charge  $Q_{rr}$  Versus  $-di_F/dt$

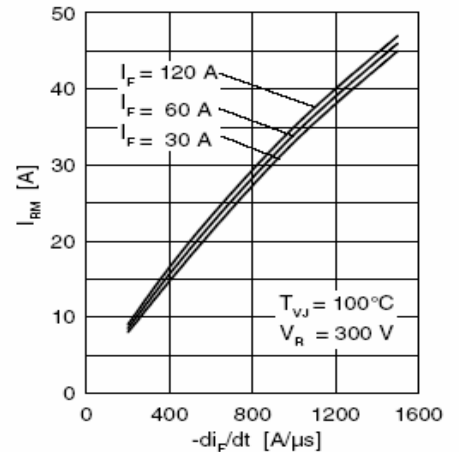

Fig. 24. Peak Reverse Current  $I_{RM}$  Versus  $-di_F/dt$

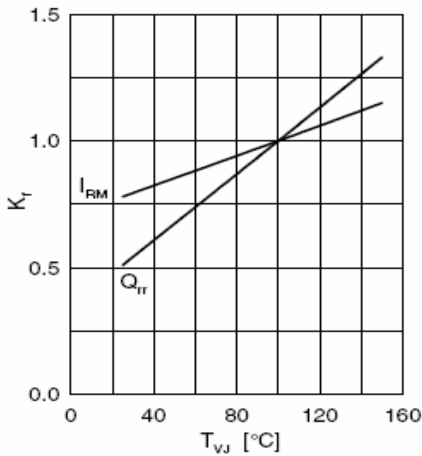

Fig. 25. Dynamic Parameters  $Q_{rr}$ ,  $I_{RM}$  Versus  $T_{VJ}$

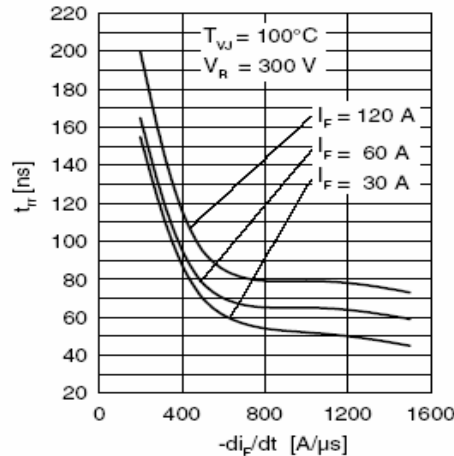

Fig. 26. Recovery Time  $t_{rr}$  Versus  $-di_F/dt$

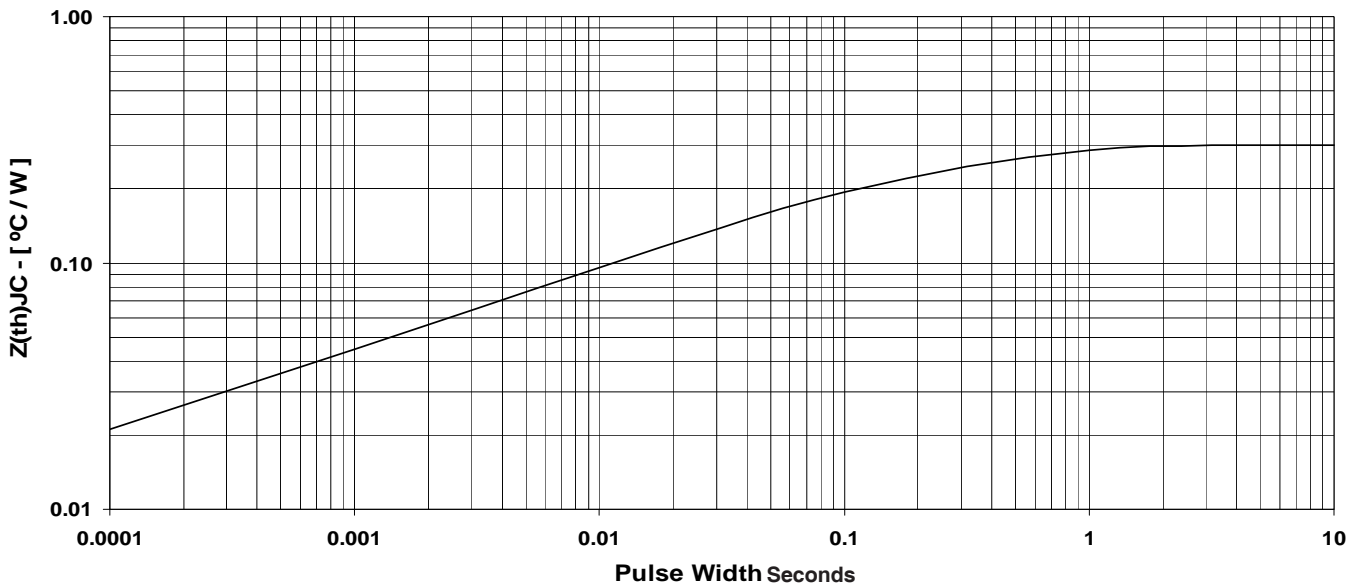

Fig. 27. Maximum transient thermal impedance junction to case (for diode)